



Bi-folding doors



Highline bi-folding door system



Focus

“In a society that celebrates the immaterial, architecture can offer a source of resistance, fighting against the erosion of form and meaning and speaking its own language.” Peter Zumthor, Architect



Contents

Bi-folding doors from Solarlux	8
Application areas	14
Opening options	18
Materials and surfaces	22
Versatility with bi-folding doors	32
Technical features	34
Ecoline and Highline	36
Megaline	40
SL 35 and SL 45	44
Woodline	48
Combiline	52
SL 97	56
System comparison	60
Windows for the bi-folding door family	62
Accessories for bi-folding doors	68
Technology	74
A sustainable, family-run company	92
Solarlux digital	98

Bi-folding doors from Solarlux

Outdoors is the new indoors

Being outside - or, even better - being able to cultivate your outdoor life in line with your own individual expectations is, for many people, the purest joy imaginable. It can improve their well-being, help them relax, and provide them with the perfect atmosphere to thrive. Being close to nature helps us feel grounded in our lives, transforming the outdoors into an extension of our man-made living spaces. It can even act as a daring alternative to the traditional concept of having your "own four walls" - emotional benefits

guaranteed. When we make a bi-folding door at Solarlux, we also create something much more valuable, something special - a literal sensation of openness that will soon become part of your "everyday" life. Ask yourself this: how many walls do you really need around you? One thing's for sure - we've got the answers. Read on, and let us inspire you.

Open living

For around 40 years, Solarlux has stood for the outstanding quality of versatile glazing solutions for public and private spaces. The bi-folding door has been the beating heart of the international, family-owned company right from the very beginning. Unlike traditional sliding doors, all the individual elements of a bi-folding door can be gathered up in a slender bundle of panels at one side. This produces generous glass fronts that can be opened across almost 100 % of their width while still offering maximum protection when closed. Its functionality, the creative freedom offered by its high-quality materials, and the limitless possibilities for combining it with other elements make the bi-folding door the ideal solution for a wide range of projects. Whether used as a passive house element that offers high levels of thermal insulation or as a non-insulated variant in a pergola - in terms of both its flexibility and the space it opens up, the bi-folding door knows almost no boundaries.





Facts that speak for themselves

In addition to their emotional value, bi-folding doors also offer tangible, quantifiable benefits. Security, accessibility, energy-efficiency, sound insulation - these advantages speak for themselves.

What Solarlux offers

- + In-depth consultation and planning
- + Patented technical details
- + Durability and high quality
- + High German production standards
- + Certified by national and international institutes
- + Maximum transparency and flexibility
- + Filigree sight lines from 99mm
- + Sophisticated technical design and installation
- + Compliance with all applicable standards and specifications



Accessibility and convenience

Bi-folding doors are extremely convenient, with accessible floor tracks available for living spaces with durable stainless steel carriages and rollers.



Slender sight lines

The most important feature of the bi-folding door is its accordion-like folding principle, which allows it to be opened across almost 100% of its width. When closed, it boasts incredibly slim sight lines of from just 99 mm across the panel butt joint.



Security and anti-burglary protection

Bi-folding doors are high-quality and extremely sturdy. They fulfil the requirements of the standard European anti-burglary protection class RC2. This even applies to systems with an even number of panels - which is a benefit you won't find anywhere else on the market.



Thermal and sound insulation

A bi-folding door guarantees optimum thermal insulation and, depending on the system and packages, can also be used for passive houses. The sound reduction index that can be achieved with these elements guarantees a quiet living space, even in bustling, built-up areas.

For rooms
without limits

Application areas

Suitable for a wide range of applications

The possibilities offered by a bi-folding door are almost limitless. It can be used as an element for a wintergarden glazed extension that can be opened across almost its entire width, employed as an alternative to a traditional patio door or window, or used as an entrance to a pool. And it's also suitable for public spaces, of course! Use it to build your shop entrance, glaze the VIP box in your stadium, or create a facade on your balustrade. In addition to bi-folding doors, you can also create entire facades using windows, top lights, fixed elements and sliding doors. And of course, all these solutions are available with harmonised profile sight lines, glass positions, material properties and surfaces - all in Solarlux quality.







SDL Avantgarde wintergarden with Highline bi-folding door



Ref. 1356* // SDL Akzent plus; Ecoline modular



Ref. 157* // SL 70e

Opening options

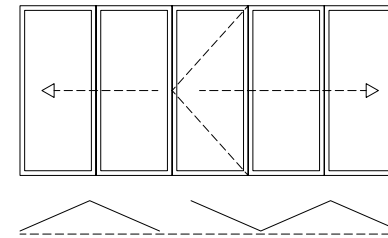
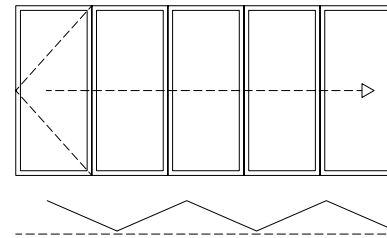
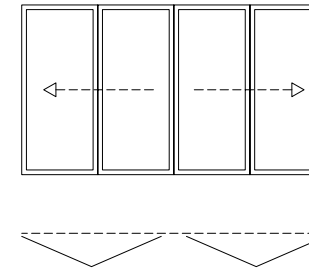
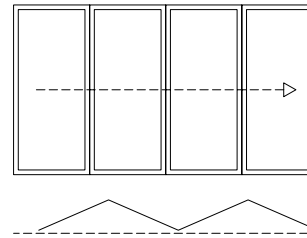

The opening options

Inwards or outwards, folding to the left and/or to the right - Solarlux bi-folding doors offer countless opening system possibilities. Thanks to the wide range of options available - including installation on a balustrade or with a segmented ground plan, for example - the systems are suited to use in a huge variety of projects. The individual glass elements can be opened or closed in just a few simple steps, across their whole area.

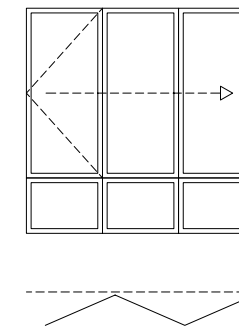
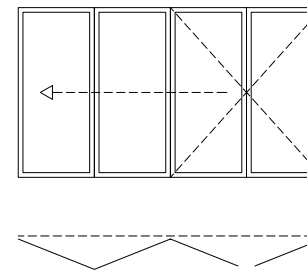

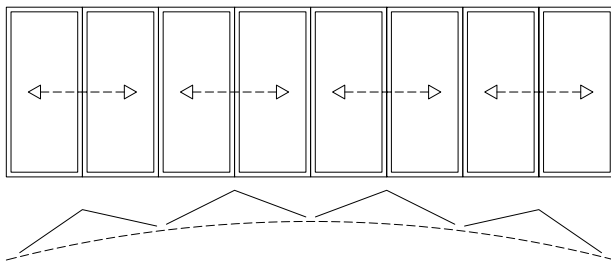
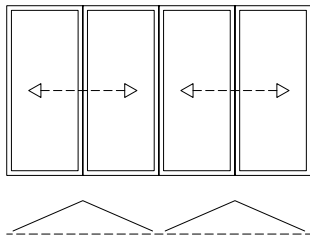
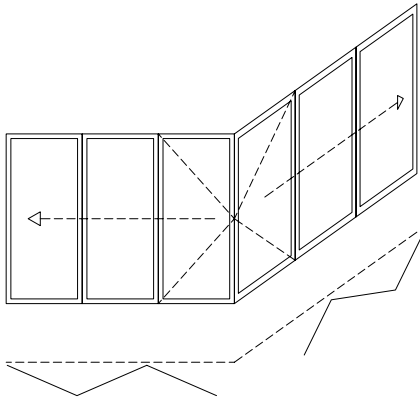

An unparalleled range of combination options!
Bi-folding doors can be combined with many other elements, such as tilt-and-turn panels, fixed elements and sliding doors. Since all our systems use the same profiles, a homogenous appearance and extensive connection options are guaranteed.



Ref. 575* // Woodline

© Studio PROTOTYPE



Ref. 575* // Woodline

Materials and surfaces

Proven quality

Test certificates from reputable national and international institutes guarantee the highest level of quality for every Solarlux bi-folding door. In addition to complying with the glass standard DIN 18008, it goes without saying that all our systems also bear the CE marking. This European seal of approval confirms that Solarlux products comply with DIN EN 1090, which has been mandatory for all manufacturers of steel and aluminium supporting structures since 2014. This system is used throughout Europe to demonstrate when a factory has been certified and carries out its own production control.

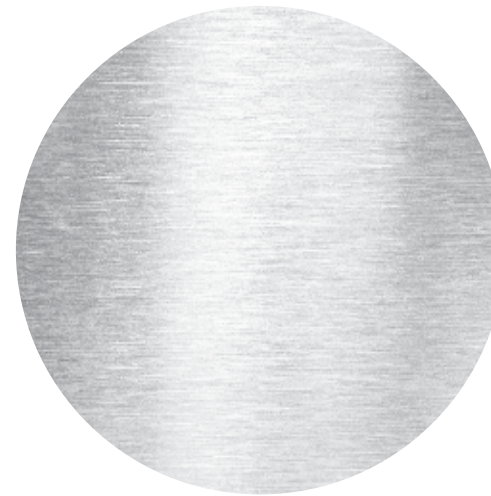

Aluminium - Durable and low-maintenance

The use of aluminium profiles guarantees facades and window elements that are durable, low-maintenance and, above all, weather-resistant. We also apply environmental awareness to our aluminium production - Solarlux is certified in accordance with the German A.U.F. Recycling Loop, which has confirmed that our aluminium is recycled in a 98% environmentally conscious manner that saves on resources. All of our aluminium bi-folding doors are available in any colour - including special colours, Eloxal and DB with metallic iron effect.



Our colour options

When you choose a Solarlux bi-folding door, you opt for individuality. Solarlux standard colour options, which include around 30 RAL colours, offer all the colours of the rainbow in matt and gloss finishes, at no extra cost. This allows every bi-folding door to match its building's interior and exterior design. We use our own in-house coating plant - one of the most modern in Europe - for top surface quality.





The Solarlux coating is certified to international standards

Special colours

It goes without saying that we also offer special DB (metallic iron effect) and RAL colours, as well as special surface finishes (e. g. by Tiger) for anyone looking to give their bi-folding door a unique twist. We can make almost any wish come true - and we also offer coatings for special climate requirements (e.g. coastal properties).



In order to ensure aesthetic harmony, especially in bi-foldings with darker colours, we offer handles in the “black titan” colour. This colour application process produces a scratch-proof surface finish that is a lot less susceptible to wear than other techniques. We are also currently working on an anti-burglary protection lever door handle with an adapted surface.

Wood - Individual and natural

The production of wooden systems requires sensitivity, experience and optimum wood treatment. This is the only way to ensure that the numerous benefits offered by wood - such a unique material - come into their own perfectly. Light or dark, textured or smooth - together with our wide range of paints, varnishes and oils, the woods we use here at Solarlux provide a huge range of colour and design options.



Das Zeichen für
verantwortungsvolle
Waldwirtschaft



PEFC004-31-1592
Förderung nachhaltiger
Waldwirtschaft

www.pefc.de

Sustainable in almost every way

The woods used by Solarlux are FSC® and PEFC™-certified, and are sourced from sustainable forestry. Both our certificates in this area set very high standards, particularly in terms of sustainability, the environmental sustainability of the forest cultivation, the quality of the work, and the social expertise of the forestry companies we work with. Our use of water-based finishes and energy-saving production with recycling of water and heat provide further evidence of the care with which we handle our natural resources.

This means that when you choose wood as your material, you are opting for a natural raw material. In addition to spruce and pine, we also offer a wide range of other timbers, depending on the grain. Our surface treatments are completely individual, too. Whether you opt for a varnish, a hand-oiled surface or an opaque lacquer, your bi-folding door is available in almost any colour, completely independent of the manufacturer.



As well as our standard colours,
Solarlux systems are available in any
other colour of your choice



HSM 111 Clear
Meranti



HSM 999
Meranti



HSM Opal White
Spruce



TSM 111 Semi-matt
Oak



HSM 344
Pine



HSM 322
Spruce



HSM 111 Clear
Spruce



HSM 444
Meranti



HSM Antique Oak
Oak



HSM RAL 7016
Meranti



HSM 455
Meranti

Actual colour may vary due to
differences in the wood used and
its condition, or inaccuracies
resulting from the printing process.
Such differences do not constitute
grounds for complaint.

Appearance and surface finish

Our surface treatments are completely individual, too. Whether you opt for a varnish, a hand-oiled surface or an opaque coating, Solarlux products are always available in any colour of your choice. For our coating materials, we generally rely on premium quality from Remmers. However, we can of course also use paints provided by sikkens, Adler or Teknos on request to ensure that your Solarlux system perfectly matches your existing windows and doors.



Degrees of gloss

Create a completely individual style and appearance for your bi-folding door - thanks to the huge range of RAL colours, varnish shades and oiled finishes we offer for our wooden surfaces, plus your choice of a matt or silk gloss finish. There is no extra charge for different degrees of gloss.



Colour: Teak
Wood: Spruce

Colour: Teak
Wood: Meranti

Colour: Teak
Wood: Oak

Colour: Teak
Wood: Accoya®

Your choice
makes all
the difference

Versatility with bi-folding doors

The system family

The bi-folding door family includes aluminium, wood and wood/aluminium systems, and offers decisive benefits: perfected technical details such as a patented carriage, TwinX® panel centring mechanism, accessible floor tracks and frame cladding are used for every system in the product range, while the specific requirements of the wood or aluminium profiles are also incorporated into the technical design. This “system for all seasons” also comes with advantages in terms of installation: thanks to their harmonised design and sophisticated

fitting technology, every system in the bi-folding door family is quick to install and easy to adjust. This not only provides maximum room to manoeuvre, but also helps to ensure that your project goes off without a hitch.





Technical features



Carriage

The stainless steel carriage with double-layered grooved ball bearings runs smoothly and quietly. It offers optimum load transfer onto its carriage and running track, allowing it to carry even heavy panels with little effort. The entire stainless steel sliding mechanism is extremely low-maintenance and non-wearing.

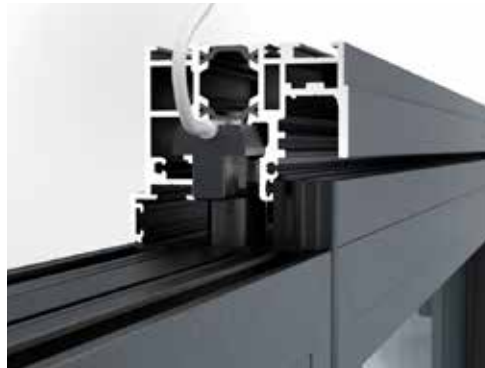

Locking mechanism

With its 24 mm latch bolts that slot into the top and bottom of the frame, the Solarlux special gearbox provides a high level of security. It can be fitted with a reed-contact closing monitor and concealed wiring, and is available in RC2 or RC2N design.



TwinX®

The TwinX® concealed panel centring mechanism stands for uniform, homogeneous panel design (only the top and bottom hinges are visible). Keeping the panels centrally aligned with one another, it provides stability even when the system is subjected to high wind loads, and ensures that the joint alignment remains even. It also ensures that the sealing levels remain unchanged and uninterrupted throughout the system.



Panel catch

The “Comfort Snap” functional panel catch offers incredible convenience when operating your bi-folding door. The swing panel can be opened and closed easily and securely by following the set sequence: once fully opened, the swing panel snaps onto the next panel, and is not released until it is closed again.



Frame cover

The polyamide frame cover conceals all the mounting screw heads. In addition to this, the hollow space between the base of the profile and the cover can be used to lay concealed cables or house an additional convection chamber interruption seal.



Cleaning pin

The “cleaning pin” is convenient to lock and unlock, and makes cleaning the outer faces of the panels easy, even on the upper floors of tall buildings. Thanks to its new locking technology, it is impossible to operate incorrectly. The new safety lock prevents the hinge pin from falling out.



Ecoline and Highline

 Aluminium

Incredibly slim sight lines,
patented technology

Despite their differences in overall depth (67 mm and 84 mm), both our thermally insulated bi-folding door systems, Ecoline and Highline, boast a slim sight line of 99 mm at the panel butt joint. This is thanks to the heart of the bi-folding door: the bionicTURTLE®, a multi-functional break profile that combines a range of technical details. Its shape helps to keep profiles extremely slim - even when using large and heavy panels. It also houses the locking mechanism and fittings that grant the systems their perfect insulation.

The Ecoline and Highline are more than merely functional - they also boast an impressive design. This has even been confirmed by renowned international experts - the new bi-folding door has won four awards.

Ecoline

- Overall depth: 67 mm
- Sight line: 99 mm
- Glass thickness: 5 - 36 mm
- $U_w \geq 1.1 \text{ W/m}^2\text{K}$
- Panel width: Up to 1m;
Panel height: Up to 3 m
- Panel weight: Up to 90 kg

Highline

- Overall depth: 84 mm
- Sight line: 99 mm
- Glass thickness: 22 - 60 mm
- $U_w \geq 0.8 \text{ W/m}^2\text{K}$
- Panel width: Up to 1.1m;
Panel height: Up to 3.5 m
- Panel weight: Up to 110 kg







Ecoline

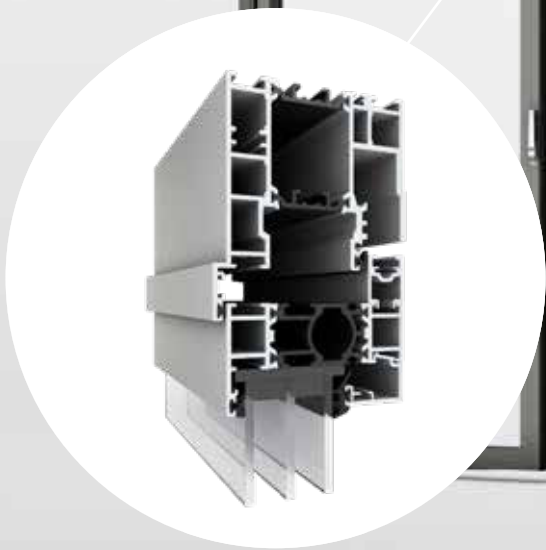

Megaline



Aluminium

Solarlux quality - no job too big

The Megaline bi-folding door with excellent thermal insulation is designed for use wherever extra-tall or wide panels are required. Depending on the height of the system, multiple sets of system hinges can be installed above one another. This guarantees a high degree of stability for the panels - which can weigh up to 150 kg each - even at high wind loads. With a maximum panel height of 4.5 m (or a panel width of up to 1.5 m), it can be used to create incredibly large glass surfaces (e.g. panels that cover two storeys) without compromising on ease of use or movement.

- Aluminium profile system with high-performance thermal insulation
- Panel height: Up to 4.5 m tall or 1.5 m wide for extremely demanding applications
- Sight line: 132.5 mm in the panel butt joint
- One-sided double profile on the vertical panel profile
- Maximum weight: 150 kg per panel
- $U_w \geq 0.9 \text{ W/m}^2\text{K}$
- Horizontal rails may be necessary for structural reasons, for construction heights over 2.55 m
- The specially shaped stainless steel running track with tapered track roller allows for the use of accessible floor tracks in accordance with DIN 18040

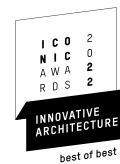





Megaline



SL 35

SL 35 and SL 45

 Aluminium

Wind & weather protection for balconies & patios

Depending on their requirements, some projects are also suited to the use of non-insulated bi-folding doors. These elements can be used as on balcony balustrades, glazing under a glass canopy, or in any situation where thermal insulation is not important, e.g. as internal partitions.

SL 35 features

- Cleaning pin for cleaning the outer faces of the panels on upper levels
- Highly sturdy thanks to tongue-and-groove joint and sturdy corner joints

SL 45 features

- One section of the panel opens inwards, the other outwards
- System can be segmented up to 22.5°

SL 35 and SL 45 - Fact sheet

- + Non-insulated aluminium systems
- + Overall depth: 35 mm/45 mm
- + No upstream running tracks or guide rails
- + Low-wear, even after 10,000 operations
- + Flush floor track without rebate for accessible living
- + Two all-round sealing levels to protect against wind and rain





Ref. 1237* // SL 45

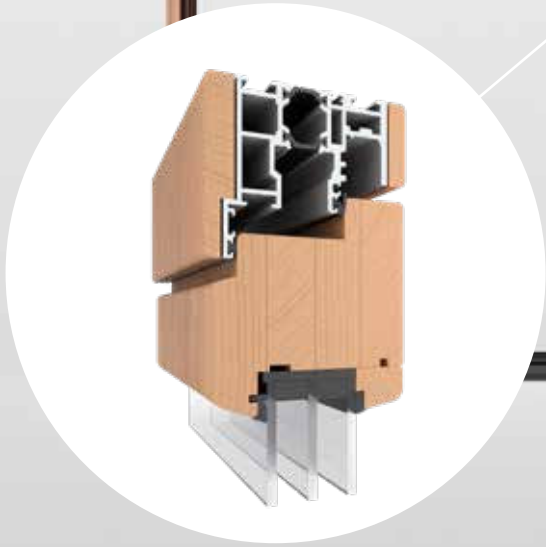

Woodline



Cosy living with an individual touch

A cosy yet modern living space - the Woodline bi-folding door is the perfect choice for those who want the best of both worlds.

Its profiles are made from multi-laminated, high-quality wood, while a special panel corner joint gives the system additional stability. The sub-frame comprises an aluminium structure that is completely clad in solid-wood sections, inside and out. The slender sight line in the panel butt joint - just 143 mm - ensures maximum transparency when the doors are closed, in keeping with your natural approach to living.

- Overall depth: 86 mm
- Sight line: 143 mm
- Glass thickness: 28 - 48 mm
- $U_w \geq 1.0 \text{ W/m}^2\text{K}$
- Panel height: Up to 2.8 m
- Panel weight: Up to 100 kg







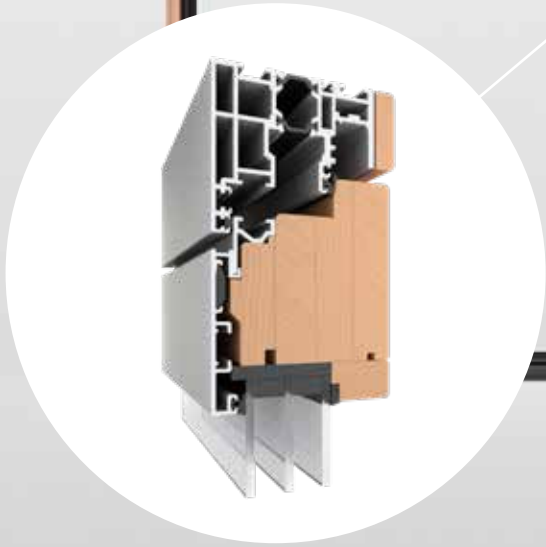

Combine



The perfect combination for a weatherproof solution

With its wood/aluminium profiles, the Combine bi-folding door provides maximum weatherproofing. This system maintains the overall panel profile depth of 86 mm, despite the square aluminium cover placed over the wood profile. The sub-frame comprises an aluminium structure that is faced with solid-wood sections on the inside of the frame. The seal encompasses two all-round sealing levels, so optimum system drainage is guaranteed.

- Overall depth: 86 mm
- Sight line: 147 mm
- Glass thickness: 28 - 52 mm
- $U_w \geq 1.1 \text{ W/m}^2\text{K}$
- Panel height: Up to 2.8 m
- Panel weight: Up to 100 kg
- Exceptionally weatherproof thanks to external aluminium covers







SL 97

Thermal insulation for
maximum energy savings

The great thermal insulation offered by the wood/aluminium SL 97 will help to bring your home closer to passive house standards. The top horizontal edge of the frame's overall depth of 92.5 mm, an additional layer of insulation, and triple glazing result in a thermal transmittance (U_w) of $\geq 0.8 \text{ W/m}^2 \text{ K}$.

- Wood/aluminium profile system with high-performance thermal insulation
- U_w of $\geq 0.8 \text{ W/m}^2 \text{ K}$
- Laminated woods with rear-ventilated aluminium covers and additional insulation layer
- System fitted with underlaid carriages as standard
- Running tracks and guide rails built flush into the system
- All designs come with swing panels
- Panels fold either inwards or outwards and slide to either left or right





System comparison

	Ecoline	Highline	Megaline	SL 35
Material				
Aluminium	●	●	●	●
Wood	○	○	○	○
Wood/aluminium	○	○	○	○
Profile				
Thermally insulated	●	●	●	○
Non-insulated	○	○	○	●
Overall depth	67 mm	84 mm	84 mm	35 mm
Panel butt joint sight line	99 mm	99 mm	132.5 mm	100 mm
Frame height	0 - 72 mm	0 - 72 mm	0 - 99 mm	5 - 70 mm
Glazing				
Glass thicknesses	5 - 36 mm	22 - 60 mm	22 - 60 mm	5 - 18 mm
Thermal insulation value				
Thermal transmittance in accordance with DIN EN ISO 10077-1	≥ 1.1 W/m ² K	≥ 0.8 W/m ² K	≥ 0.9 W/m ² K	-
Panels				
Max. panel dimensions (max. width, max. height)	1 m; 3 m	1.1 m; 3.5 m	0.9 x 4.5 m/1.5 x 2.3 m	0.9 m; 2.6 m
Panel weight	90 kg	110 kg	150 kg	65 kg
Sealing				
Resistance to wind load in accordance with DIN EN 12210	B4	B4	B4	B1
Water tightness in accordance with DIN EN 12208	8A	9A	7A	4A
Air permeability in accordance with DIN EN 12207	3	3	3	2
Burglar resistance in accordance with DIN EN 1627-1630				
	RC2 / RC2N	RC2 / RC2N	-	-
Sound reduction index in accordance with DIN EN ISO 10140-2				
	40 dB	45 dB	NPD	31 dB
Resistance to repeated opening and closing in accordance with DIN EN 12400				
	2	2	2	-

	SL 45	Woodline	Combiline	SL 97
Material				
Aluminium	●	○	○	○
Wood	○	●	○	○
Wood/aluminium	○	○	●	●
Profile				
Thermally insulated	○	●	●	●
Non-insulated	●	○	○	○
Overall depth	45 mm	86 mm	86 mm	96 mm
Panel butt joint sight line	117.5 mm	143 mm	147 mm	184 mm
Frame height	5 - 64 mm	0 - 72 mm	0 - 72 mm	45 - 108 mm
Glazing				
Glass thicknesses	5 - 20 mm	28 - 48 mm	28 - 52 mm	24 - 46 mm
Thermal insulation value				
Thermal transmittance in accordance with DIN EN ISO 10077-1	-	≥ 1.0 W/m ² K	≥ 1.1 W/m ² K	≥ 0.8 W/m ² K
Panels				
Max. panel dimensions (max. width, max. height)	1.1 m; 2.8 m	1 m; 2.8 m	1 m; 2.8 m	1 m; 2.8 m
Panel weight	100 kg	100 kg	100 kg	100 kg
Sealing				
Resistance to wind load in accordance with DIN EN 12210	-	C3	C3	C3
Water tightness in accordance with DIN EN 12208	4A	7A	7A	7A
Air permeability in accordance with DIN EN 12207	2	3	3	3
Burglar resistance in accordance with DIN EN 1627-1630				
	-	RC2 / RC2N	RC2 / RC2N	-
Sound reduction index in accordance with DIN EN ISO 10140-2				
	25 dB	42 dB	42 dB	-
Resistance to repeated opening and closing in accordance with DIN EN 12400				
	-	2	2	2



Window systems and the Highline bi-folding door

Windows for the bi-folding door family

Tilt-and-turn, tilting and fixed elements

We offer a range of window elements to match our bi-folding doors: the Ecoline and Highline aluminium systems, the wooden Woodline and the wood/aluminium Combiline model. You can integrate a traditional tilt-and-turn window, a motorised tilting toplight or fixed elements wherever you want in your system. This offers the benefit that the profiles of your windows will match your bi-folding door perfectly, creating a uniform aesthetic for the whole

combination. The window and folding elements are all treated using the same coating or painting procedure in order to ensure that there are no differences in shade or hue between the different elements.

1

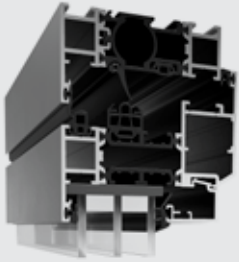

2



3

a

b

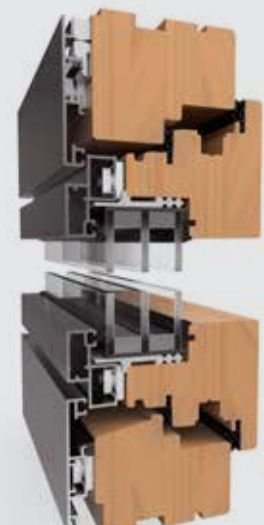
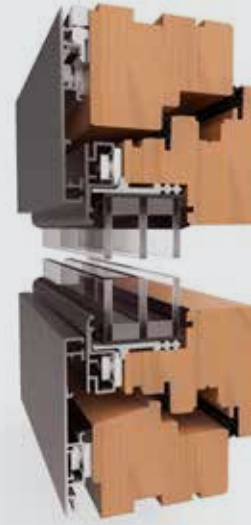

1 Ecoline & Highline

Our aluminium window elements are available in fixed, tilting and turn-and-tilt variants, with window panels that open inward to either the right or the left.

- Overall frame depth: 67 mm (Ecoline) or 84 mm (Highline)
- Minimum panel sight line: 78.5 mm or 100 mm with frame
- Fixed, tilt and turn-and-tilt elements available
- RC2/RC2N version available as an option
- Available with up to four sealing levels

2 Woodline

These window profiles are made using multi-laminated, high-quality wooden beams. Thanks to their form-fitted Plug-Tec corner joints and additional screw fittings, the panels are extremely sturdy.

- Overall frame depth: 91 mm in the panel and sub-frame profile
- All-round sight line: 72 mm for fixed window; 100 mm for element with panel
- True divided light glazing bar with range of sight lines available as an option

3 Combilline

Our thermally insulated window system with an overall frame depth of 89.5 mm in the sub-frame profile is fitted with a square aluminium cover on the outside, and available with a choice of two profile designs. The sight lines of the panel frames vary depending on which design variant you choose for your aluminium cover.

a Minimum profile:

- Panel frame almost completely covered by a square aluminium cover (sight line 88 mm)
- 10 mm all-round panel line visible in closed position

b Flush-mounted profile:

- Exterior wooden frame completely faced with an angular aluminium cover (68 mm sight line)
- Panel sheathed by a box-shaped profile (25 mm sight line)
- Continuous flush mounting between panel and frame on the exterior



Window systems and the Woodline bi-folding door

	Ecoline windows	Highline windows	Woodline windows	Combilline windows
Material				
Aluminium	●	●	○	○
Wood	○	○	●	○
Wood/aluminium	○	○	○	●
Profile				
Overall frame depth	67 mm	84 mm	91 mm	89 mm
Overall panel depth	77 mm	94 mm	91 mm	96 mm (MP), 105 mm (FP)
Fixed element frame sight line	0 - 72 mm	0 - 87 mm	0 - 72 mm / 0 - 100 mm	0 - 62 mm / 0 - 101 mm
Panel sight line	78.5 mm	78.5 mm	72 mm	72 mm (FP, MP)
Panel butt joint sight line	173 mm	173 mm	160 mm	170 mm
Frame height	Max. 2,400 mm	Max. 2,400 mm	Max. 2,400 mm	Max. 2,400 mm
Glazing				
Glass thicknesses	5 - 36 mm can be used	22 - 60 mm can be used	28 - 48 mm can be used	28 - 52 mm can be used
Dry glazing	●	●	●	●
Thermal insulation value				
Thermal transmittance in accordance with DIN EN ISO 10077-1	≥ 1.17 W/m ² K	≥ 0.88 W/m ² K	≥ 1 W/m ² K	≥ 1.1 W/m ² K
Panels				
Panel weight	Max. 130 kg	Max. 130 kg	Max. 130 kg	Max. 130 kg
Panel width	Min. 800 mm, not incl. wind and impact loads	Min. 800 mm, not incl. wind and impact loads	Min. 400 mm, not incl. wind and impact loads	Min. 400 mm, not incl. wind and impact loads
Special sizes available on request	●	●	●	●
Sealing				
Resistance to wind load in accordance with DIN EN 12210	B4	B4	C3	C3
Water tightness in accordance with DIN EN 12208	8A	9A	9A	9A
Air permeability in accordance with DIN EN 12207	3	3	4	4
Burglar resistance in accordance with DIN EN 1627-1630				
Sound reduction index in accordance with DIN EN ISO 10140-2	32 dB	32 dB	32 dB	32 dB
Resistance to repeated opening and closing in accordance with DIN EN 12400	2	2	2	2

Accessories for bi-folding doors



Fitting options

Equipment packages are available for the entire bi-folding door family. By choosing the appropriate package, customers can place greater focus on aspects such as security, thermal or sound insulation, lighting, or convenience, depending on their requirements. This range of options for picking and mixing individual options to personalise your system makes the bi-folding door even more attractive.

Floor tracks with lighting

In many types of floor track, the 3s impact protection can be fitted with LED lights and concealed cabling. The lighting creates a great ambience, especially in the evening. What's more, this orientation aid also ensures that the access and entry area is easy to find for the visually impaired, as required by German standard DIN 18040.



Shading

Solarlux pleated blinds are great at both shading you from sunlight and protecting your privacy. They can be adjusted up and down to any position or length, making them the perfect solution. They are available as single or two-part elements, and can be positioned easily by simply moving them up or down.



Our bi-folding door systems can be fitted with additional security technology as required. The options available include an RC2-certified lever door handle combined with the Solarlux convenience lock, and burglar-resistant P4A glazing certified in accordance with DIN 1627-1630.



Ref. 1606* // SL 81



What's
behind it

Ecoline

● Aluminium

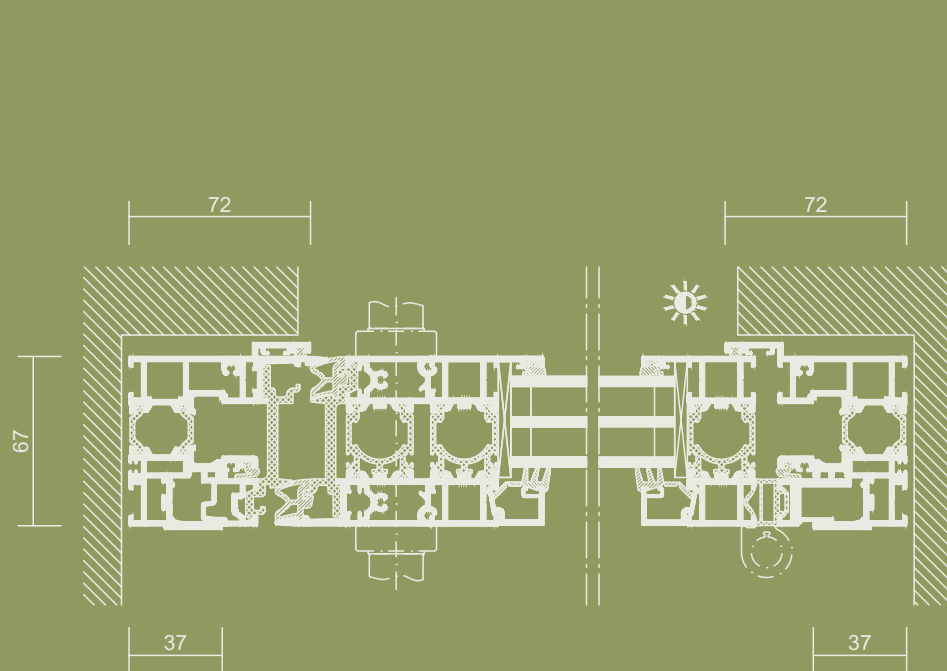

Horizontal section | without scale

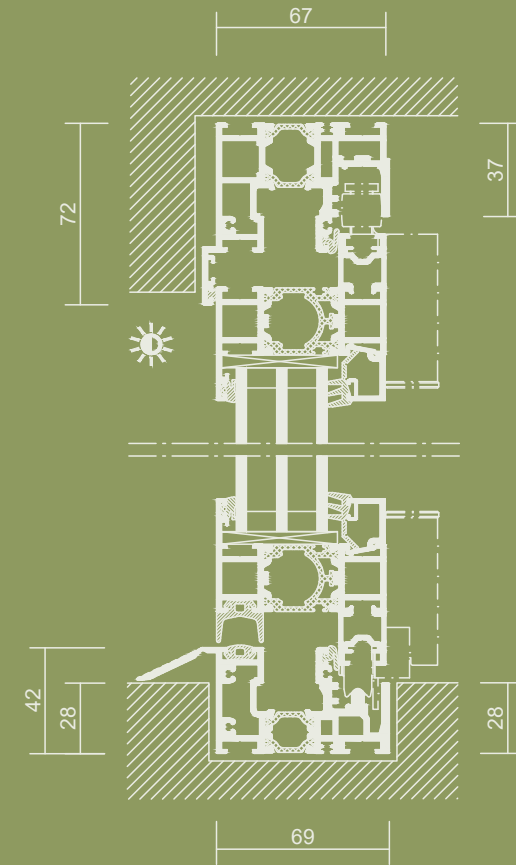

Vertical section | without scale

Highline

● Aluminium

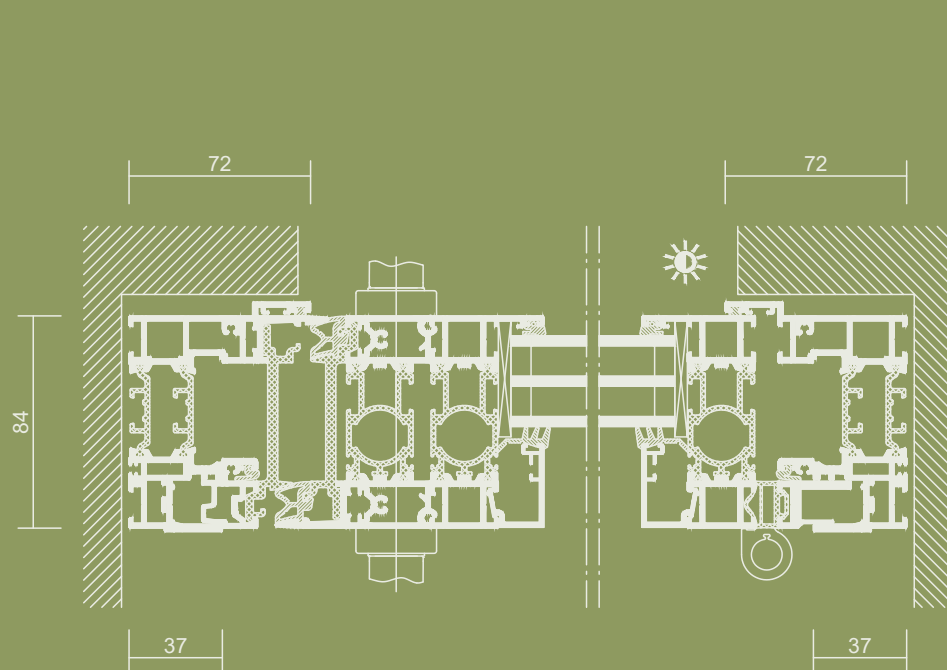

Horizontal section | without scale

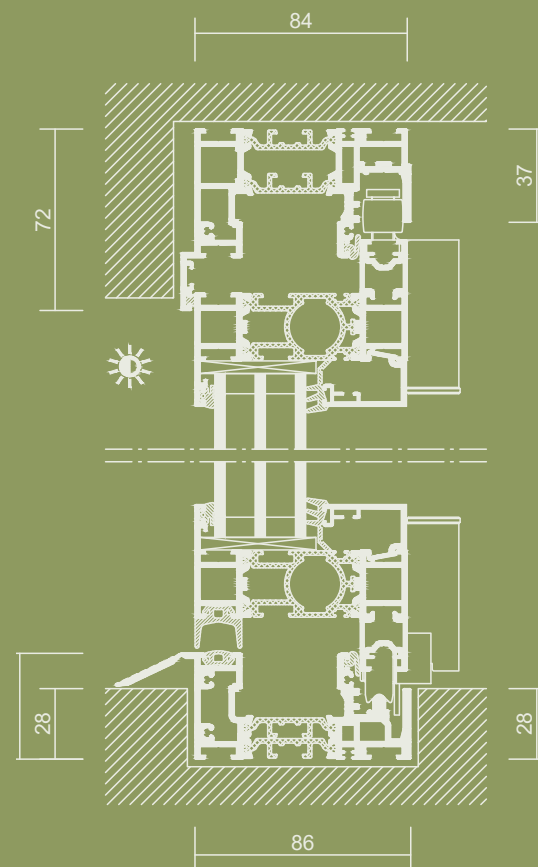

Vertical section | without scale

Megaline

● Aluminium

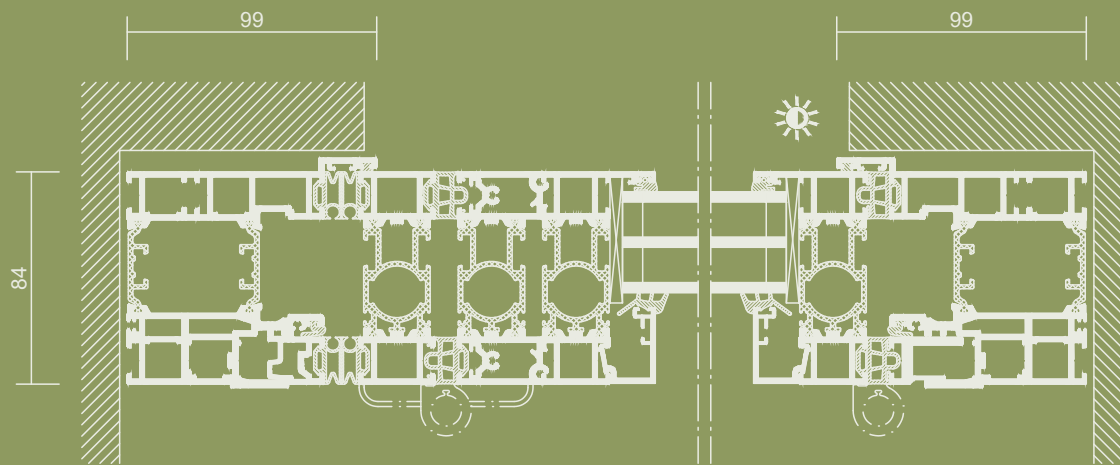

Horizontal section | without scale

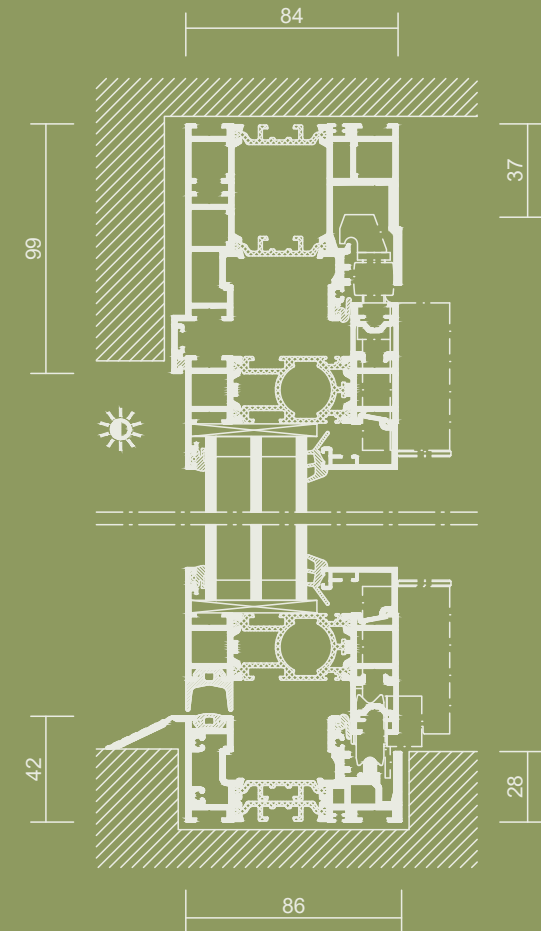

Vertical section | without scale

Woodline

 Wood

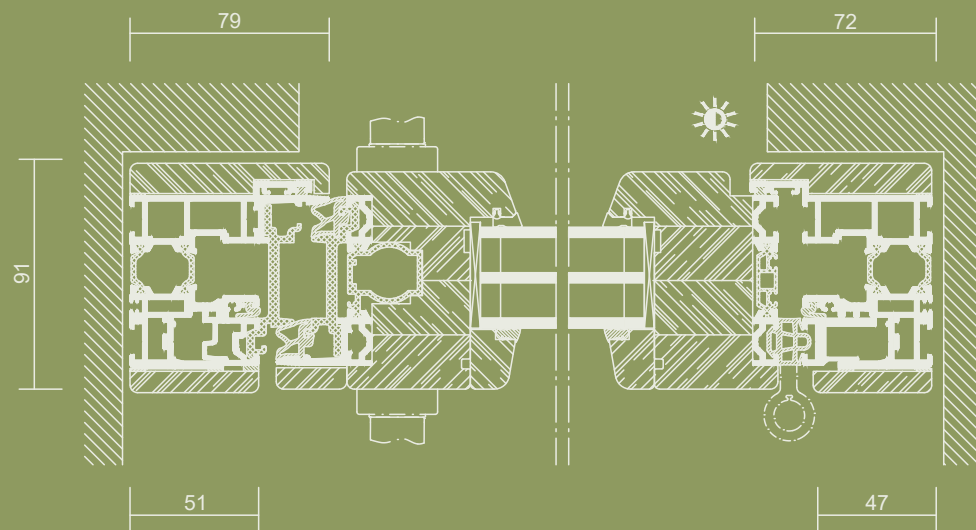

Horizontal section | without scale

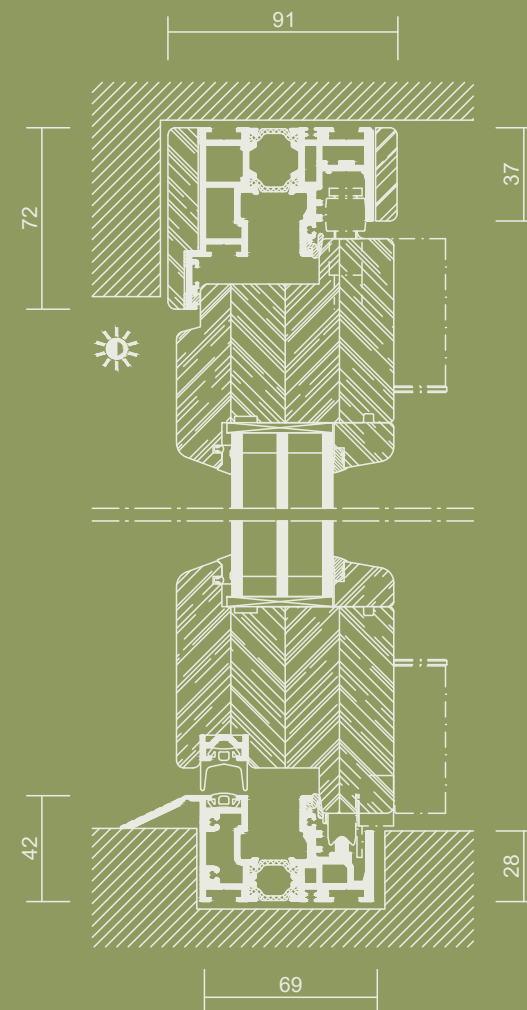

Vertical section | without scale

Combilline

● ● Wood/aluminium

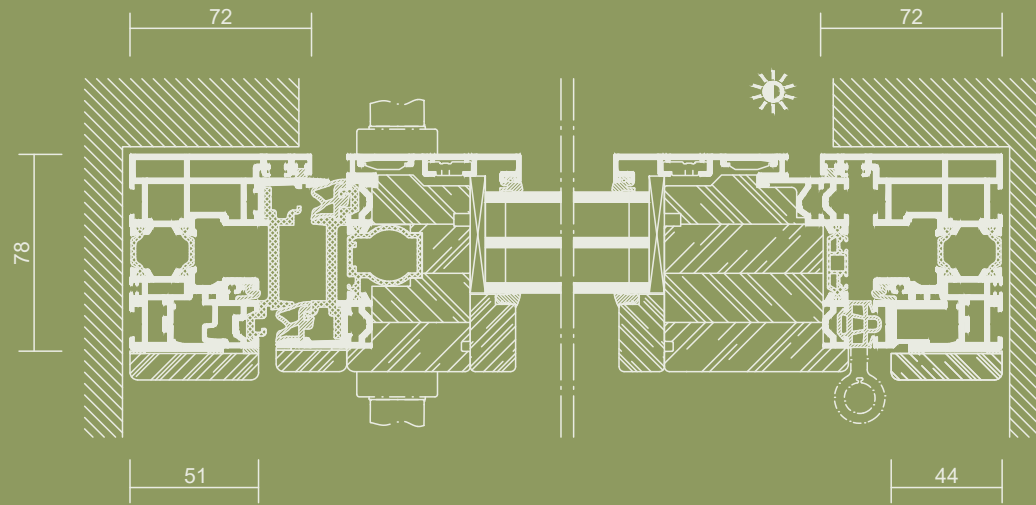

Horizontal section | without scale

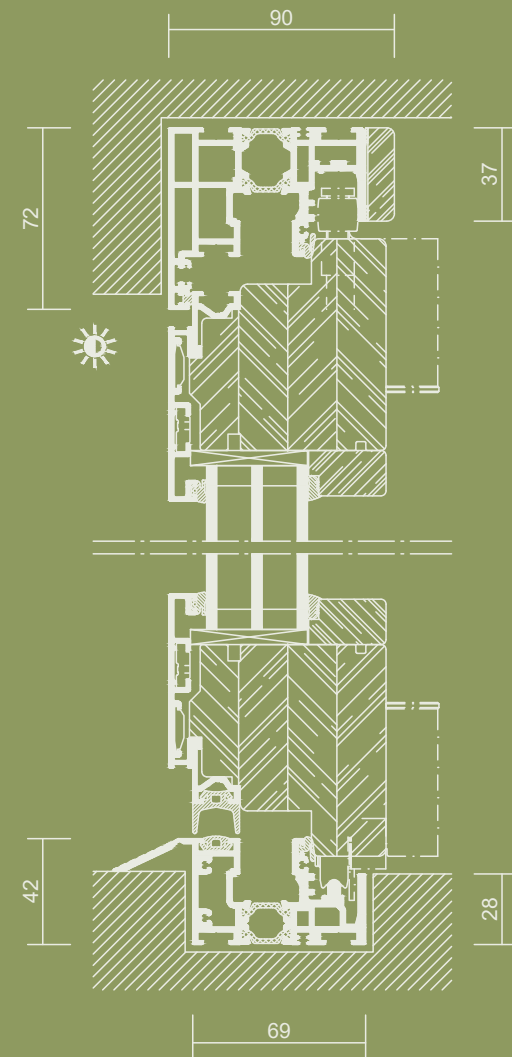

Vertical section | without scale

SL 97

Wood/aluminium

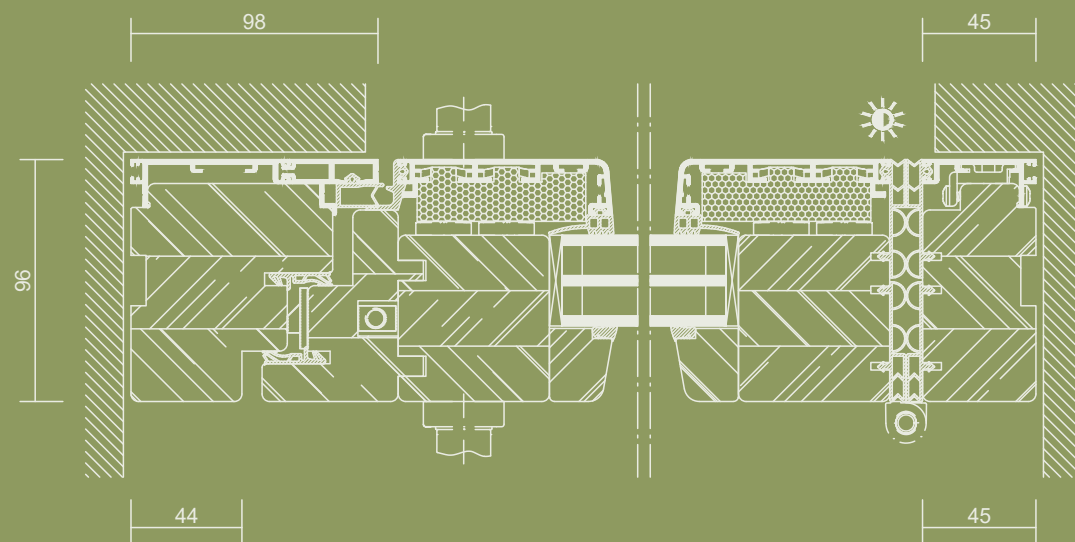

Horizontal section | without scale

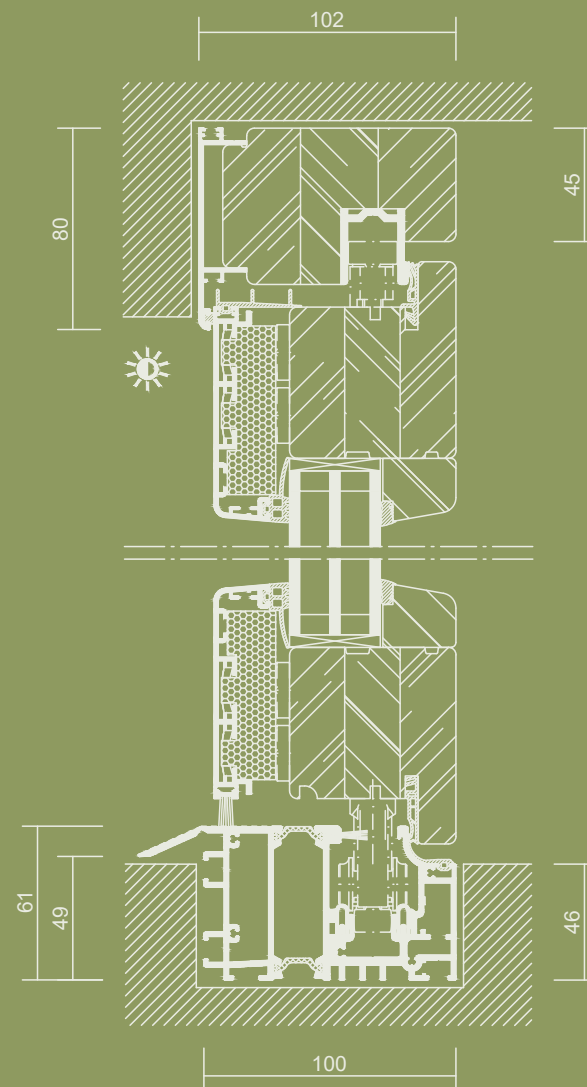

Vertical section | without scale

SL 35

● All-glass/aluminium

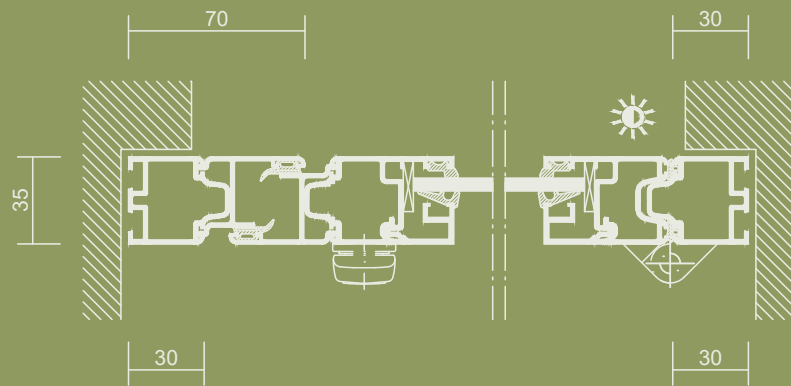

Horizontal section | without scale

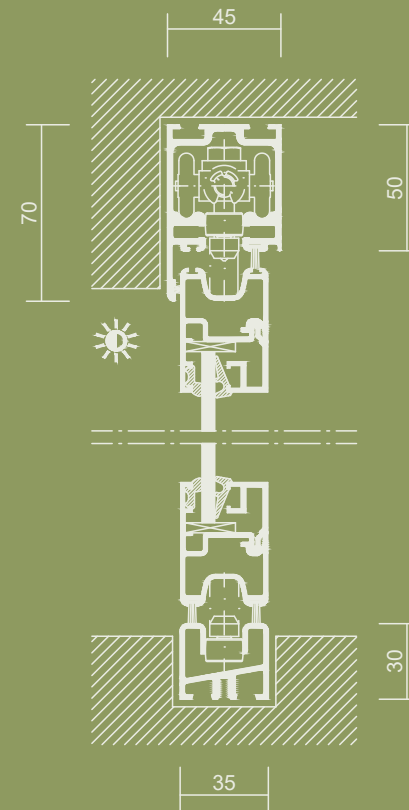

Vertical section | without scale

SL 45

● Aluminium

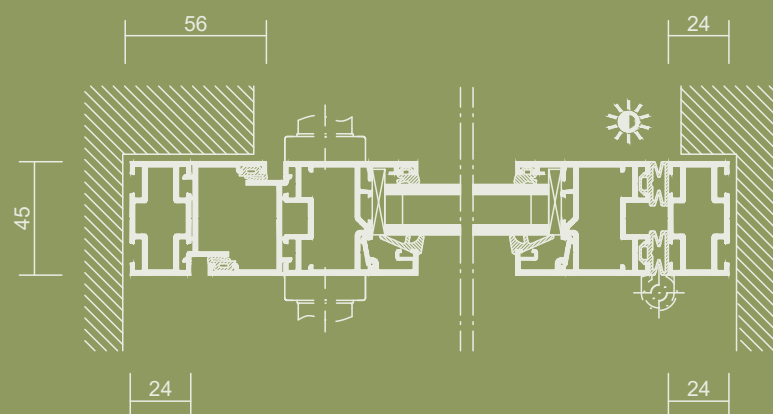

Horizontal section | without scale

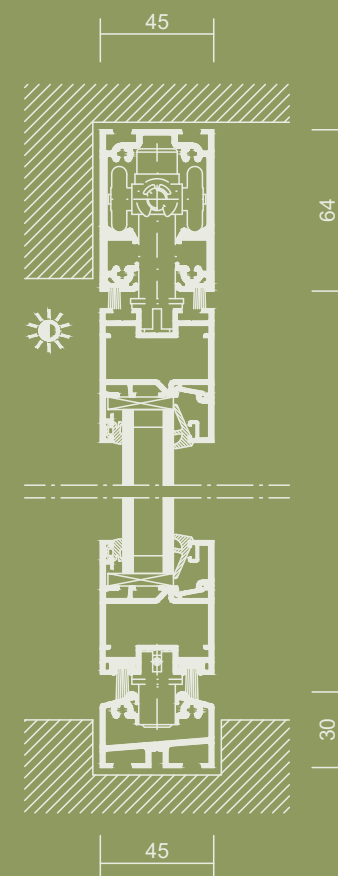

Vertical section | without scale

Floor track variants

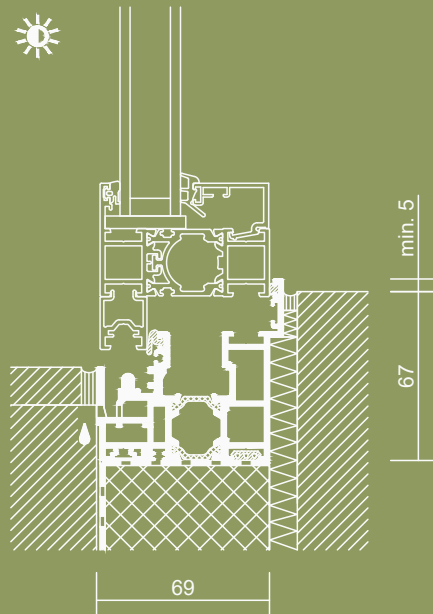

- Floor track with rebate suitable for living spaces
- Opens inwards and outwards

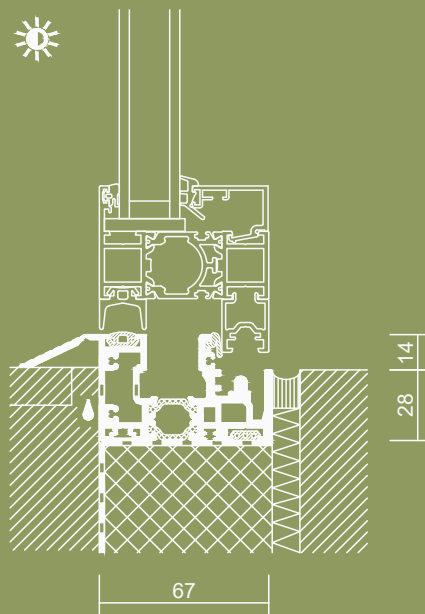

- Floor track suitable for living spaces
- Accessible with 14 mm rebate
- Opens inwards

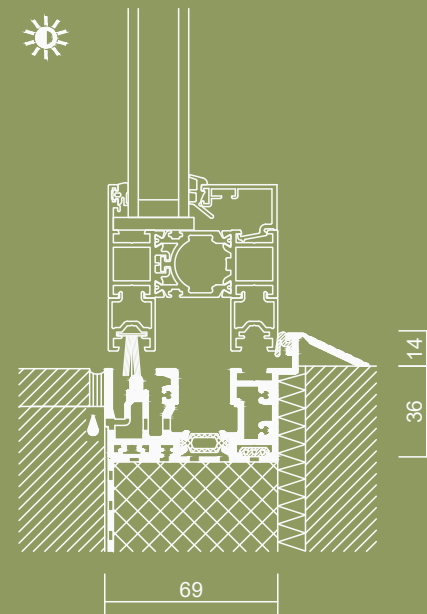

- Floor track suitable for living spaces
- Accessible with 14 mm rebate
- Opens outwards

The only way to cater for different applications is with a variety of floor tracks. We offer the right solution for every area: accessible and suitable for living spaces, with a rebate or completely flush, and even a minimalist option with a depth of just 29 mm. You can choose any of the floor tracks designed for the bi-folding door family, regardless of your material. Running tracks and guide rails are integrated into the respective systems so they do not protrude.

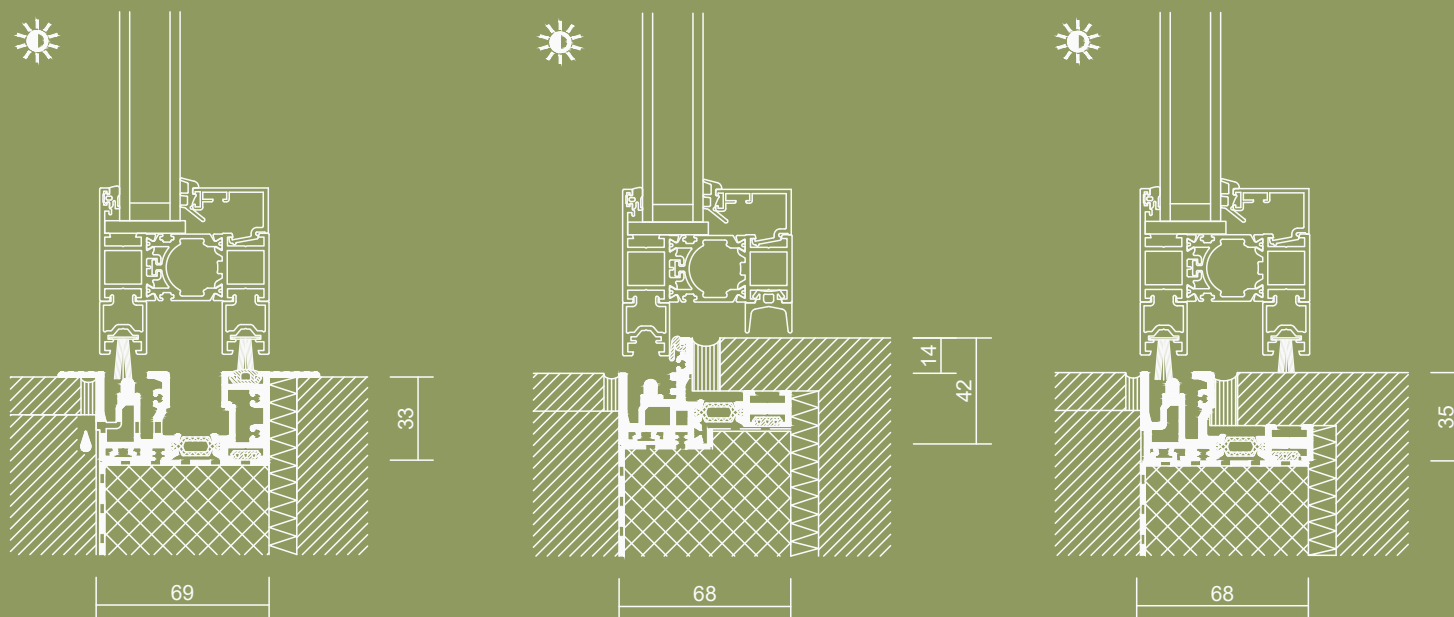

- Flush floor track
- Accessible without rebate
- Opens inwards and outwards

- Minimalist floor track (29 mm)
- Accessible with 14 mm rebate
- Opens outwards

- Minimalist floor track (29 mm)
- Accessible with 0 mm rebate
- Opens inwards and outwards

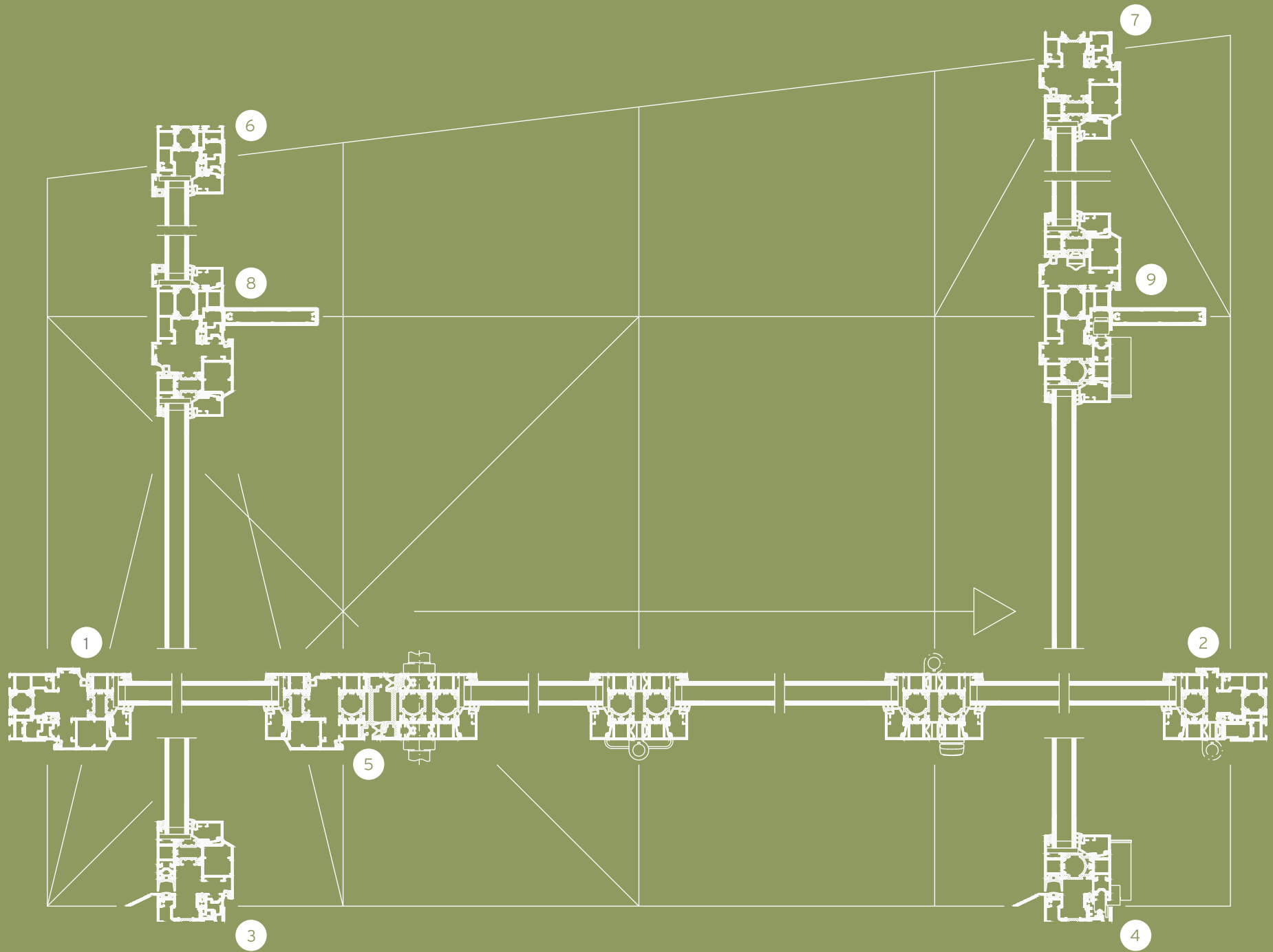

Frame solution for element combinations

In more complex projects, our remit often extends beyond simply integrating a bi-folding door into the building - other elements such as tilt-and-turn panels, fixed elements and top lights are also required. Thanks to its built-in mullion, the run-through modular frame can be used to mount a variety of elements in a single frame without joining the elements in question. This guarantees slim sight lines throughout the system.

1 2

Frame profile, left & right

Side frame profile for the tilt-and-turn element and the hinge side of the bi-folding door

3 4

Run-through floor track

Accessible floor tracks suitable for living spaces, for the tilt-and-turn element and the bi-folding door

5

Mullion profile

Thin mullion profile between the tilt-and-turn element and the swing panel of the bi-folding door

6 7

Top frame profile

Top frame profile for the fixed element and the tilting panel

8 9

Static bolt

Thin, multi-functional static bolt for absorbing transverse loads

Detail sections of window systems

Ecoline/Highline

Aluminium

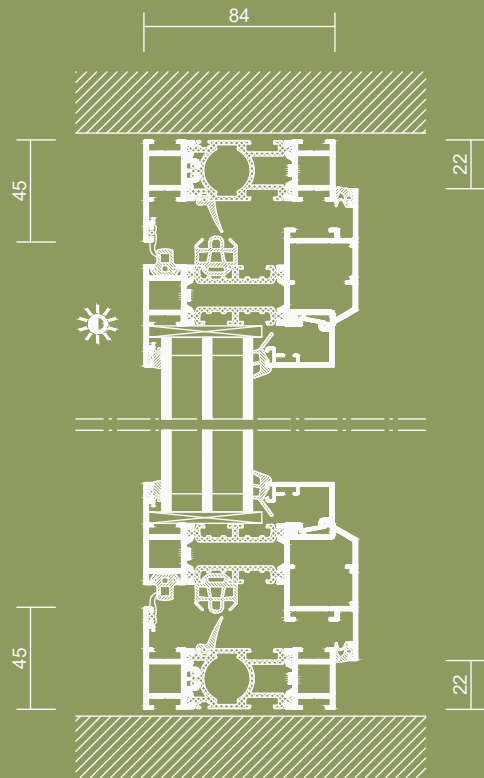

Woodline

Wood

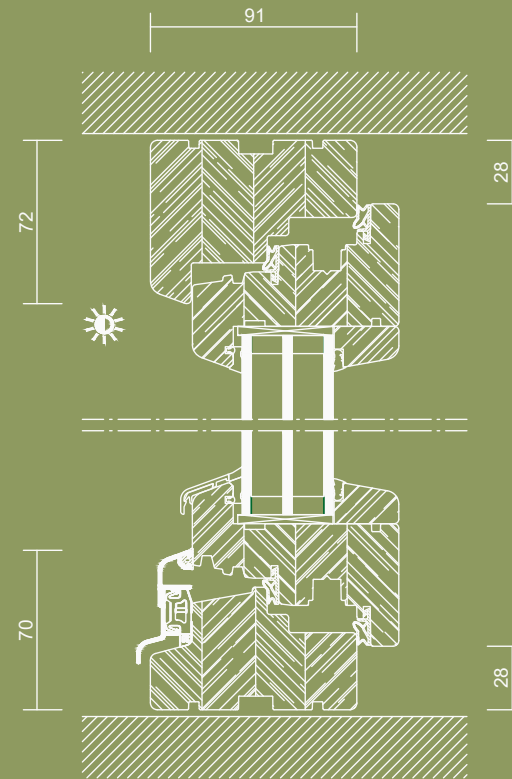

Combiline

Wood/aluminium

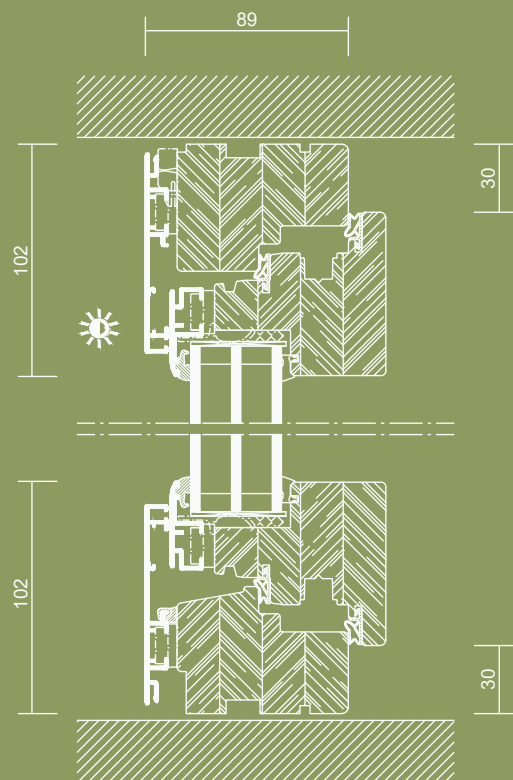

Minimal

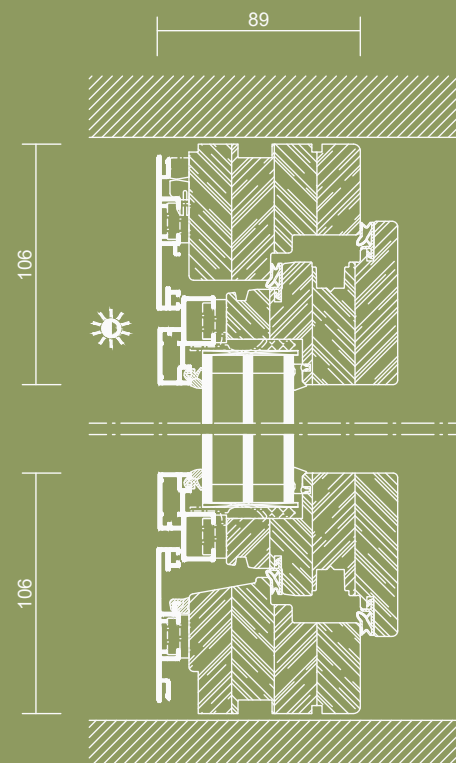

Flush-mounted

Window sill joints

Ecoline/Highline

A film seal with beading in the frame groove ensures a joint that provides protection against wind and driving rain. The window sill joint below the frame profile allows controlled drainage of any water. This prevents water from entering the building structure.

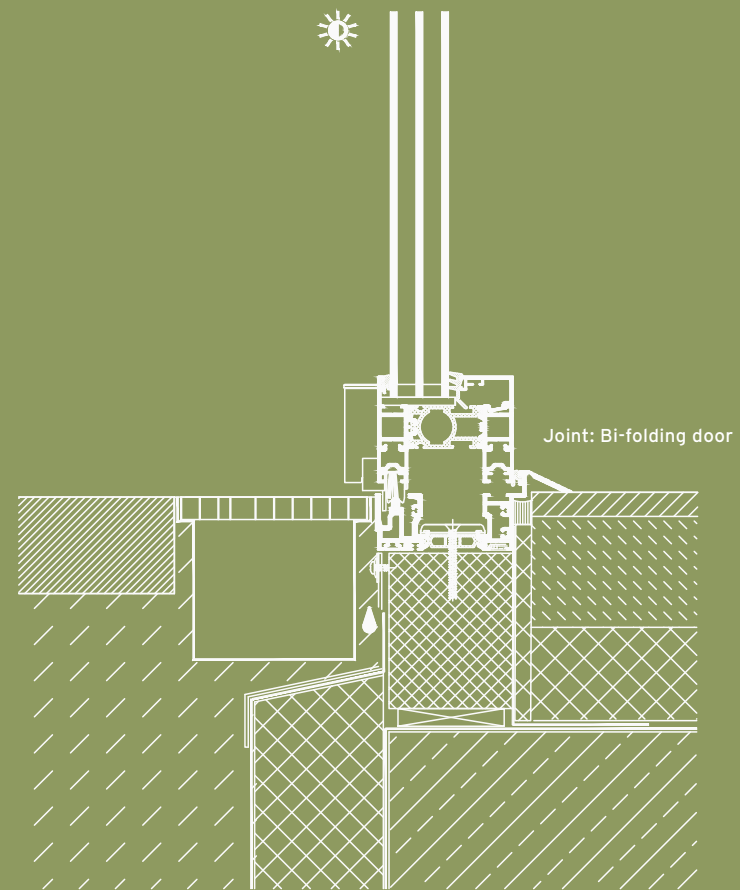

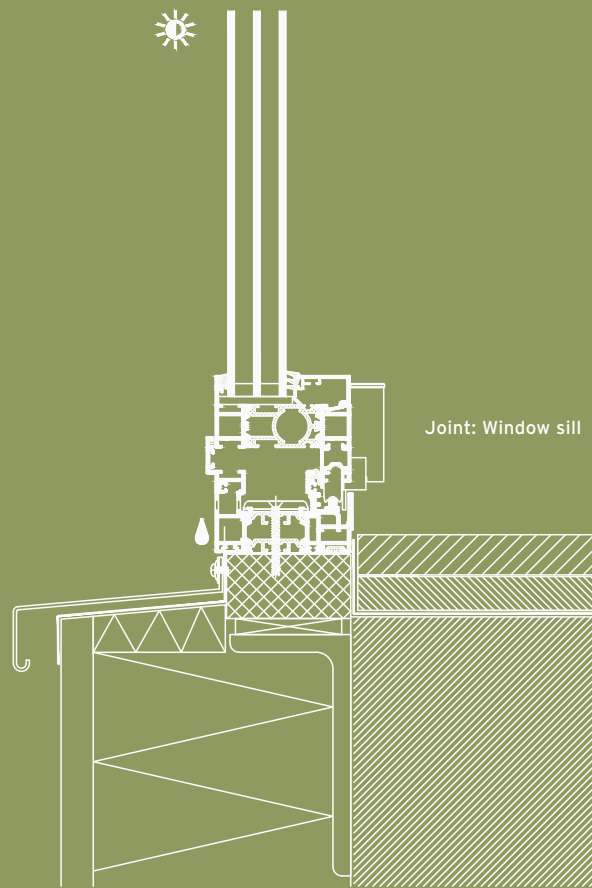

Place
your trust in a strong
company

A sustainable, family-run company

Down-to-earth, innovative and passionate

For around 40 years, Solarlux has represented exceptional quality in the production of bi-folding doors, winter-gardens and facade solutions. Founded by Herbert Holtgreife and Heinz-Theo Ebbert (+ 1990) and based in the town of Melle, north-west Germany, the company is now managed by Holtgreife's son, Stefan. But the real driving force behind Solarlux is its employees: a workforce of around 1,000 dedicated and imaginative staff who are vital to the leading system provider's success.

The company's environmentally friendly approach to production, in-house production control structure and compliance with the highest quality standards are reflected in its ISO 9001, ISO 50001 and DIN EN 1090 certificates. When combined with the extensive community outreach that has been part of Solarlux ever since it was founded, this truly makes the family-owned company something special.

The Solarlux Campus

We see ourselves as pioneers of solar architecture. Large-scale transparency dissolves the boundaries between inside and the outdoors - but it also offers much more besides. The double-skin facade acts as a climate buffer zone in summer, while also generating solar energy in winter and the cooler months. By combining this with geothermal energy and a cogeneration unit, the Solarlux Campus is able to reach an energy level well above the average for an industrial building of its size. The gigantic photovoltaic system on the roofs of the production areas generates an output of 1.5 MWp and covers almost 70% of the building's electricity requirements. The rest is provided by the cogeneration unit. The resulting carbon offset is more than the combined emissions of 400 four-person households - per year. As a result, the Solarlux Campus is already almost completely energy-neutral - and we're working on achieving full energy neutrality, too.



Stefan and Herbert Holtgreife





Our world



What does Solarlux stand for?

- Family-run company
- Certified in accordance with ISO 9001
- In-house research and development
- Partner to renowned architects' bureaus all around the world
- 1,000 employees worldwide
- Projects successfully completed in more than 60 different countries
- Community outreach, sense of responsibility for people and nature



Production

- A 57,000 m² production site
- High-tech industrial production with a manufacturing philosophy
- In-house painting line and powder coating plant
- Sustainable and energy-saving
- Certified energy management in accordance with ISO 50001





Products

- Designed, engineered and made in Germany
- CE-approved
- Certified and independently tested
- Winners of national and international design awards
- Equipped with the best profile surfaces
- Compliant with the strictest quality standards
- Individual custom products made to order



Service

- Top-class consultation, everything from a single source
- Professional implementation of private and public building projects
- Digital customer portal with personal project documents
- Professional partner network
- Maintenance and service agreements that also extend beyond project completion
- Tidy installation



Solarlux digital

More inspiration

Projects, references, news - the world of Solarlux moves fast, and an image is sometimes worth a thousand words. What more reason do you need to visit our website or the mySolarlux portal, or to follow us on social media? You can open our mySolarlux customer portal by simply scanning a QR code attached to your system, allowing you to access all the information relating to your project or order accessories, for example.

But even in this digital age, it should go without saying that we love hearing from you directly and answering your questions in person or on the phone. So don't delay - contact us today! Whether you'd like a zero-obligation consultation session, a sketch of your personal idea, or simply an answer to a question, there are plenty of ways to get in touch with us.



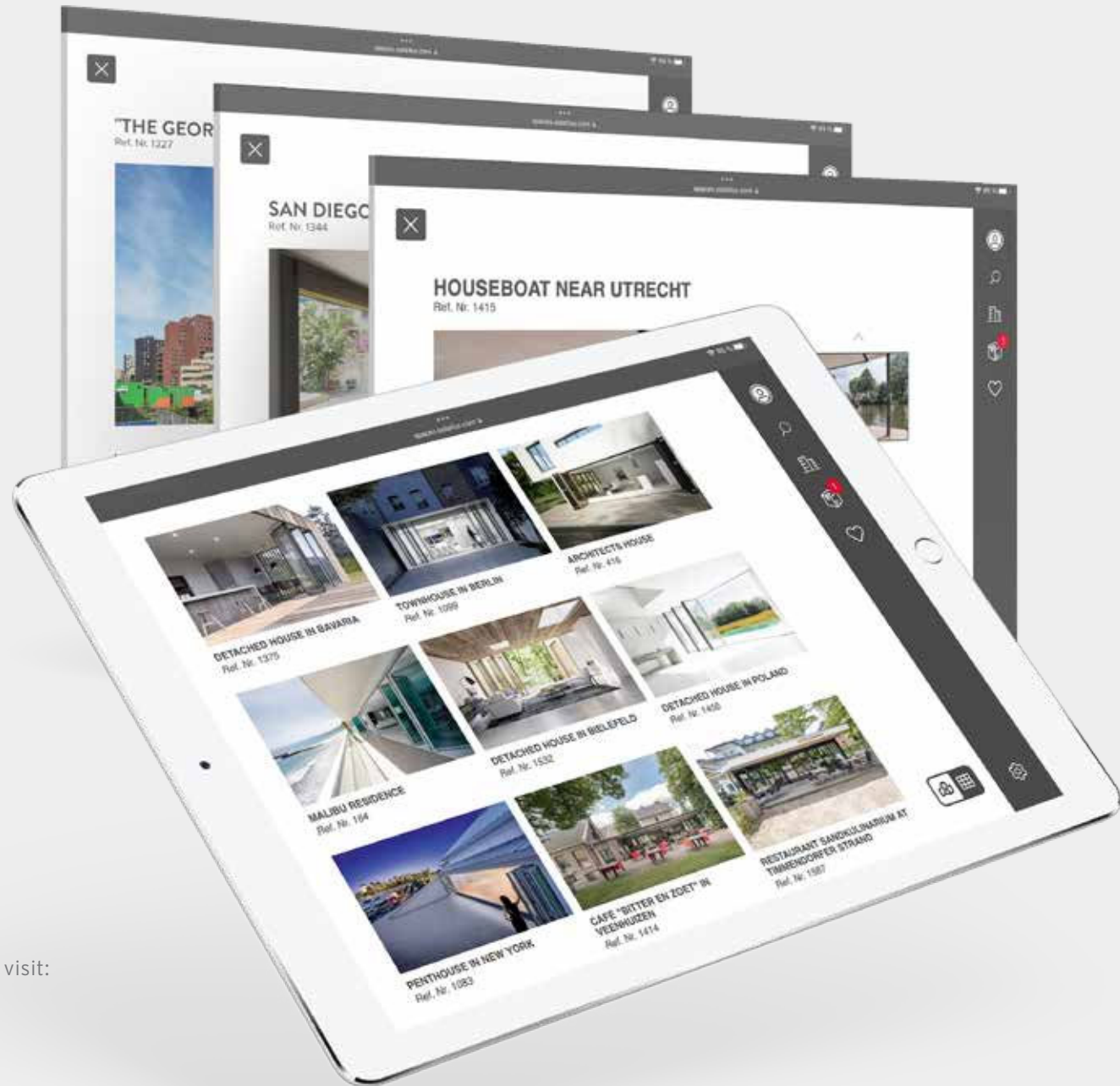

For more information, visit:
solarlux.com

