



cero sliding door







Contents

Design and application areas	08
Atmosphere	10
Engineering	54
Sample configurations	54
Features	58
Drive	62
Security	70
cero III system details	72
cero II system details	76
cero I-s system details	80
System overview	84
Additional components	86
References	92
cero by Solarlux	112
Digital and direct	120

cero

“Form follows function - that has been misunderstood. Form and function should be one, joined in a spiritual union.”

Frank Lloyd Wright

Design and application areas

Minimal

The cero sliding door operates within the parameters of aesthetics, functionality and quality. Its slender frames and profiles help to make the elements transparent. Its narrow profiles and slim, all-round panel frames, which are only 34 mm wide, underline the minimalistic design without compromising on aspects such as security, convenience and performance.

Pleasing to the eye

Light-flooded rooms with maximum transparency are not exclusive to certain projects or building types. The desire for light, air and aesthetically pleasing design is universal. From large projects, cultural buildings and restaurants to apartments and houses; with its 98% glass design and a large glass panel size of up to 15 m², the cero has an attractive aesthetic, wherever it is used.





Atmosphere

“In the real world, however, architecture is three-dimensional, and is not just there to look at, but to smell, hear and feel. A sensual experience. The most important ingredients are well-known: space, light, materials (and materiality), sound, proportions, relationship to the location, and even temperature. And last but not least: people.”

Susanne Kippenberger, “Inner Values”





cero III

Summer house

Denmark

Architect: Jan Wenzel

Photos: Malik Pahlmann

Ref. 1731*

*Note: Further information about all the reference numbers provided can be found at spaces.solarlux.com













zero III

Schwielowsee residential and office building

Potsdam, Germany

Architect: Scheidt Kasprusch Architekten

Photos: Rainer Gollmer

Ref. 1720*











A photograph of a misty landscape. In the foreground, there is a dark, grassy field. In the middle ground, a dense line of trees is visible, partially obscured by a thick layer of white mist or fog. The background is a clear, pale blue sky. The overall atmosphere is serene and quiet.

zero III

"Kösching" office building

Ingolstadt, Germany

Architect: abhd architekten denzinger und partner mbb

Reference photographs: Maximilian Gottwald

Ref. 1666*









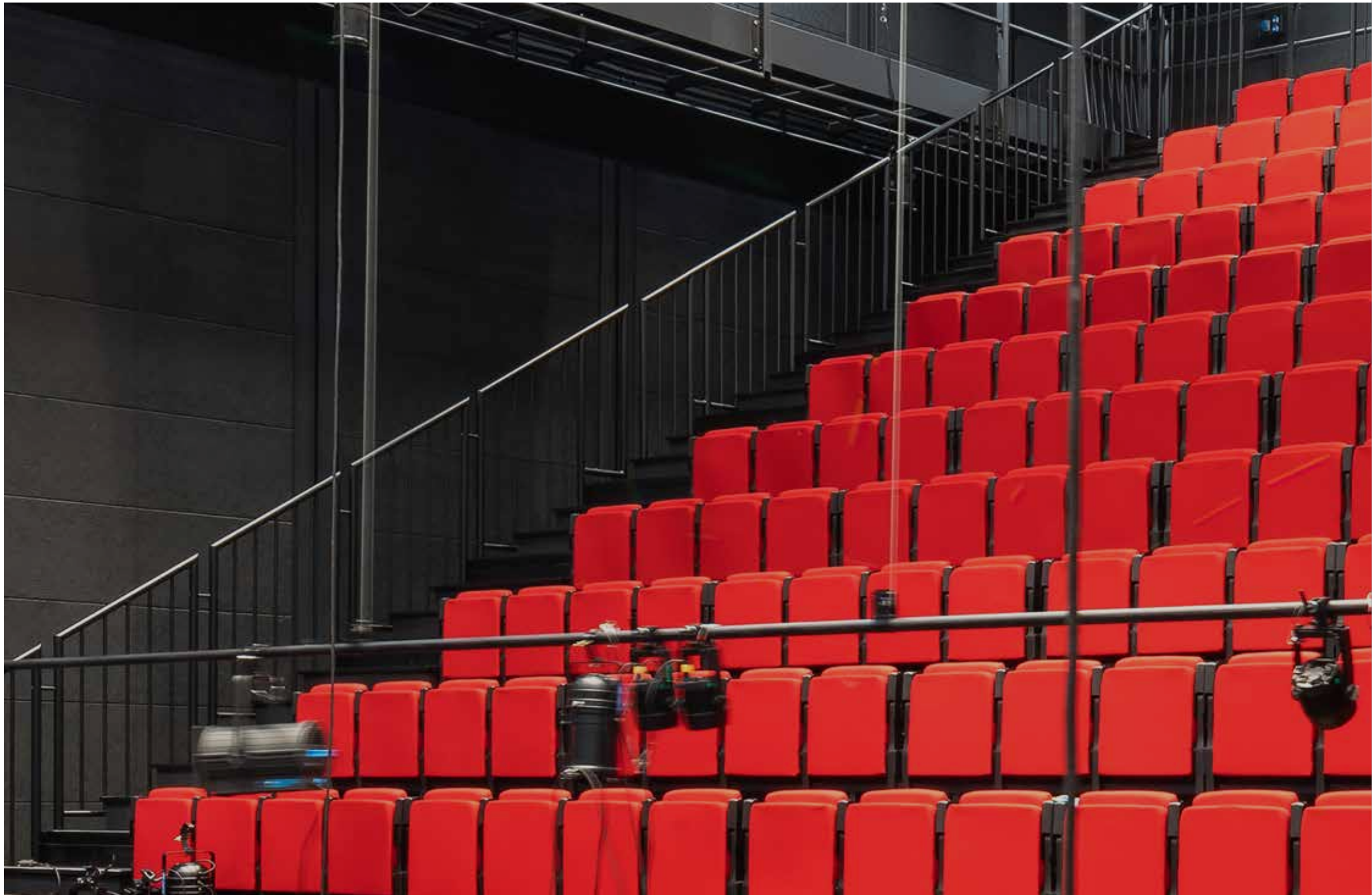

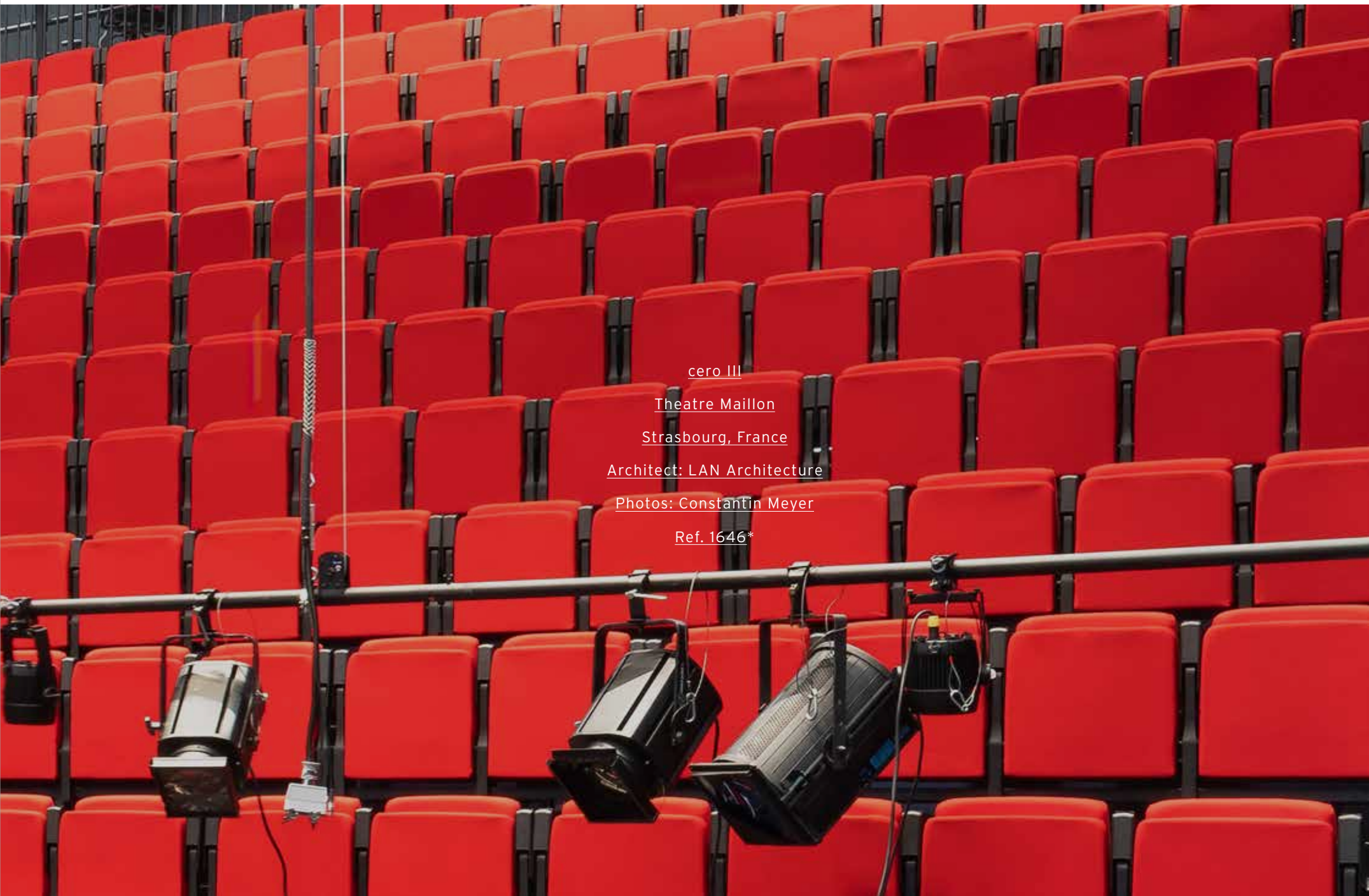

cero III

Theatre Maillon

Strasbourg, France

Architect: LAN Architecture

Photos: Constantin Meyer

Ref. 1646*





La fin d'un cycle est toujours
l'attente de
Nouvelles rencontres
- Les Semaines
- Les Journées
- Les Ateliers
- Les Conférences
- Les Séminaires
- Les Colloques
- Les Cours
- Les Travaux Pratiques
- Les Stages
- Les Projets
- Les Interventions
- Les Conférences
- Les Séminaires
- Les Colloques
- Les Cours
- Les Travaux Pratiques
- Les Stages
- Les Projets
- Les Interventions

La fin d'un cycle est toujours
l'attente de
Nouvelles rencontres
- Les Semaines
- Les Journées
- Les Ateliers
- Les Conférences
- Les Séminaires
- Les Colloques
- Les Cours
- Les Travaux Pratiques
- Les Stages
- Les Projets
- Les Interventions
- Les Conférences
- Les Séminaires
- Les Colloques
- Les Cours
- Les Travaux Pratiques
- Les Stages
- Les Projets
- Les Interventions









cero III

Apartment

Berlin, Germany

Architect: Kirchberger & Wiegner-Rohde

Reference photographs: Felix Brüggemann

Skyline Berlin: Daniel Sumesgutner

Ref. 1714*













cero III

Detached house

Zwolle, Netherlands

Architect: Boxis Architecten

Reference photographs: Danielle Malestein

Ref. 1288*













cero III

Spa pavilion

Vienna, Austria

Architect: Smartvoll Architekten

Photos: Dimitar Gamizov

Ref. 1719*









Sample configurations

Room design

When it comes to the question of where and how cero can be used, almost anything is possible. The system components, in the form of sliding, fixed and corner elements, can be combined in almost any configuration and offer the complete freedom of design that sophisticated projects and clients require. Corners without posts, elements that can be moved into niches in the wall, and complex combinations of different elements can be achieved using two to four tracks to create custom solutions. Panel sizes of up to 6 m tall or 4 m wide and a maximum panel weight of up to 1,000 kg create new, open dimensions in the room.

Track for one panel

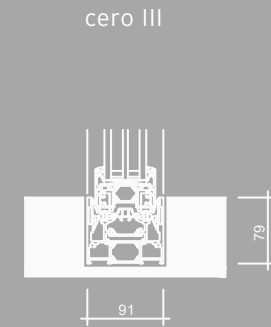
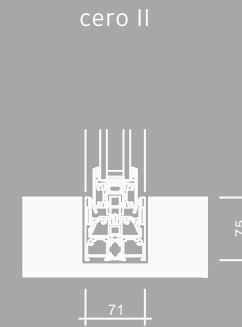

Track for two panels

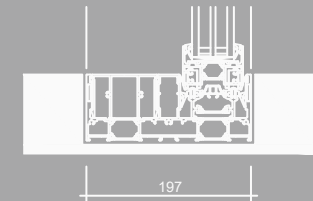
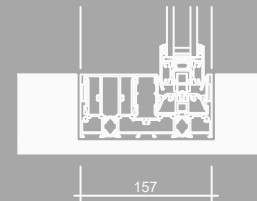

Track for three panels

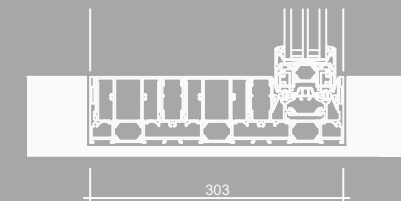
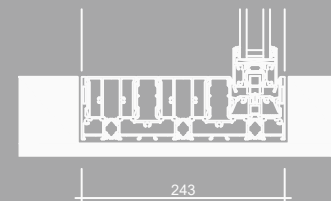



6

3

1

2

4

5

Floor tracks

The running tracks and guide rails are flush-mounted and when installed provides accessibility in accordance with DIN 18040. For zero II, an insert in the floor track that matches the material of your interior design (e.g. tiles, parquet, marble) ensures a harmonious, aesthetically pleasing appearance both inside and out. The flush-mounted floor track can be either installed level with the indoor floor, or given a slight ramp on the inside and/or outside. The overall frame depth varies depending on how many tracks you require; for zero II, for example, it would be between 71 mm (single-track), 157 mm (two-track) and 243 mm (three-track).



Floor track
with infill profile

Flat floor track
(cero II)



Flat floor track
with ramp (cero II)



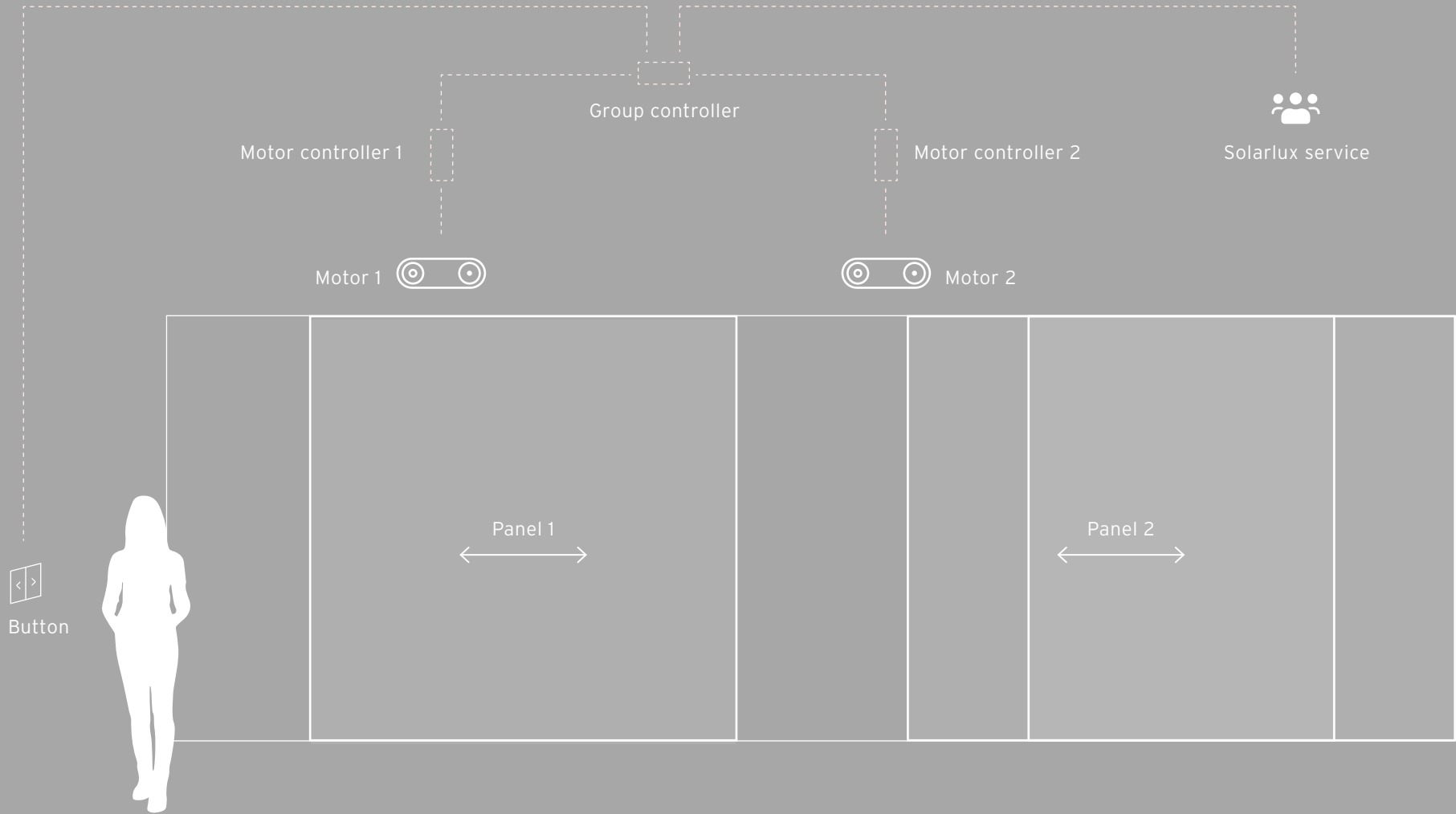

The controllers can be placed next to the motor, or in an accessible control cabinet.

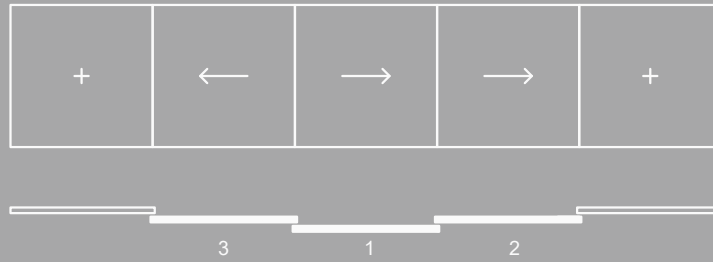

The system is closed



Panels 1, 2 and 3
open simultaneously

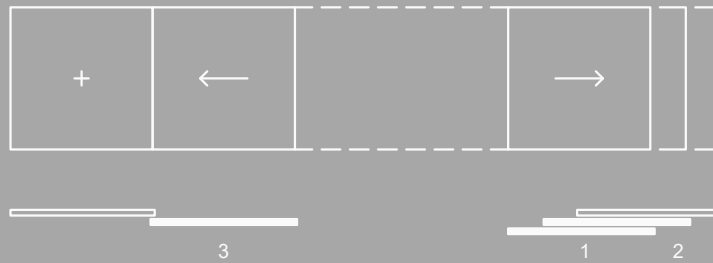

Only panels 1 and 2
open simultaneously

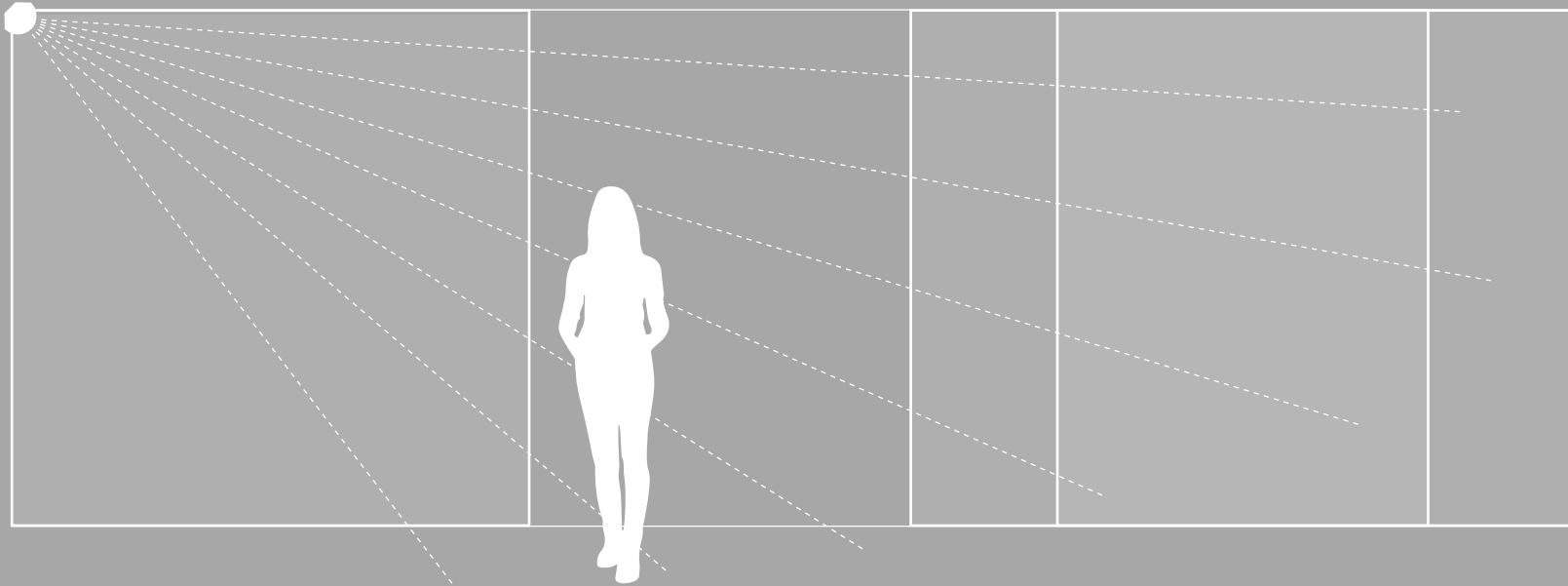



(Image shows an example solution from GIRA; other systems also available)

Automatic operation

All opening and closing sequences can also be selected on a control panel. The control command then proceeds in a single process, without the need to keep pressing the button. Fully automated operation uses laser scanners on the inside and outside. The scanners ensure that the system automatically comes to an immediate stop if a person or object enters the danger zone. Opening or closing then continues as soon as the danger zone has been vacated again, without needing to reinitiate the process on the control panel.

Smart home

The cero's control system can also be integrated in a building's on-site automation system. This connects the cero's automatic operation to an existing, open smart home system, allowing the resident to open and close their cero easily via an app.

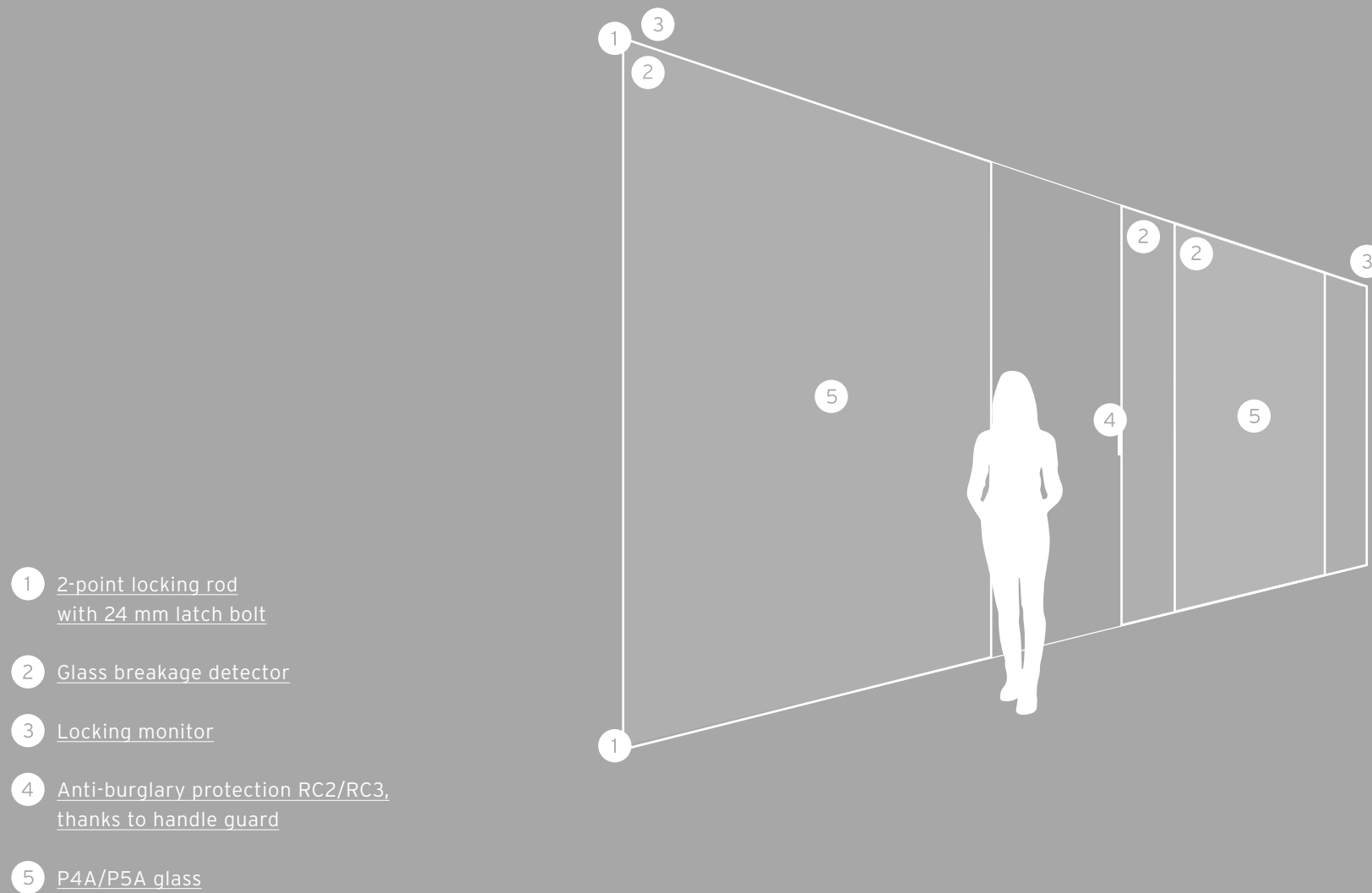



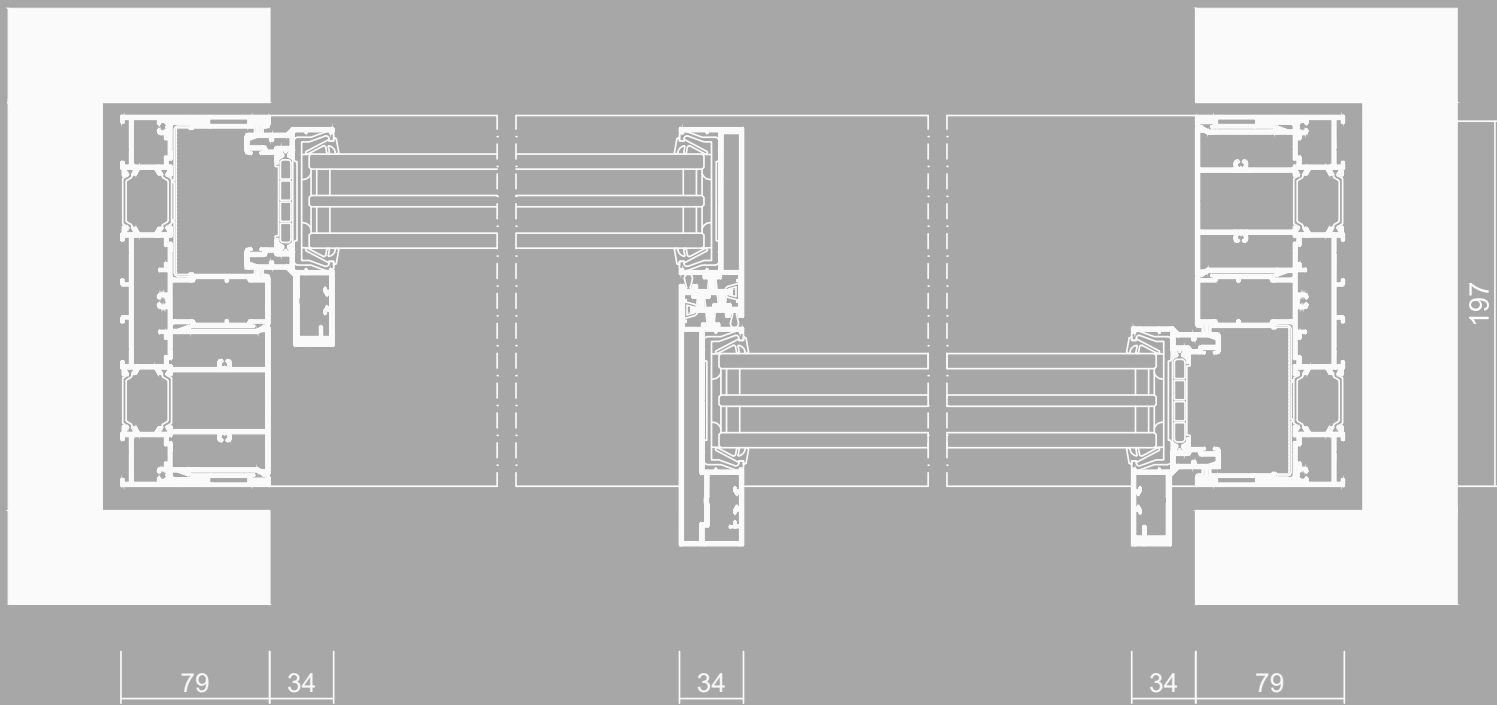

Horizontal section | without scale

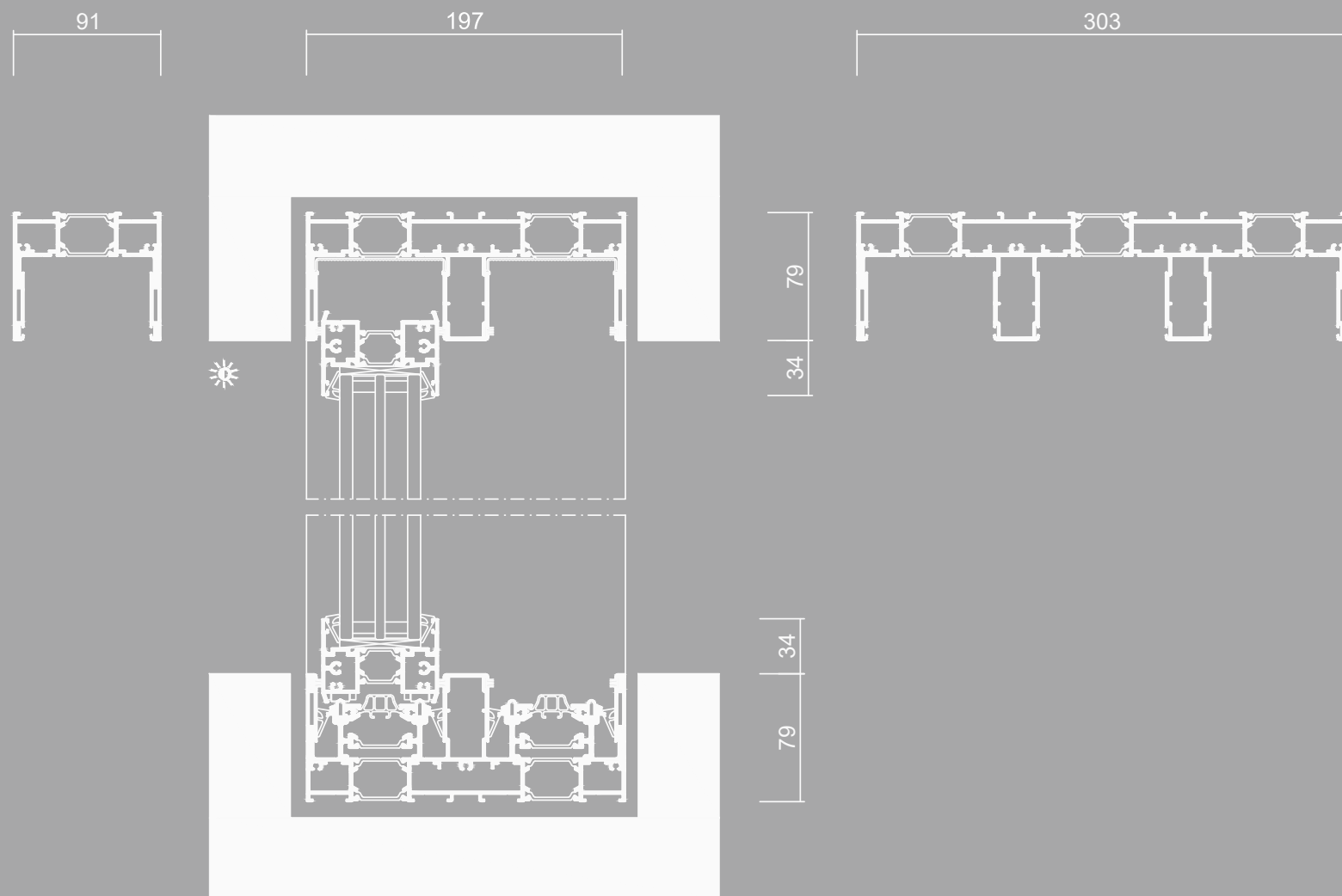

Vertical section | without scale



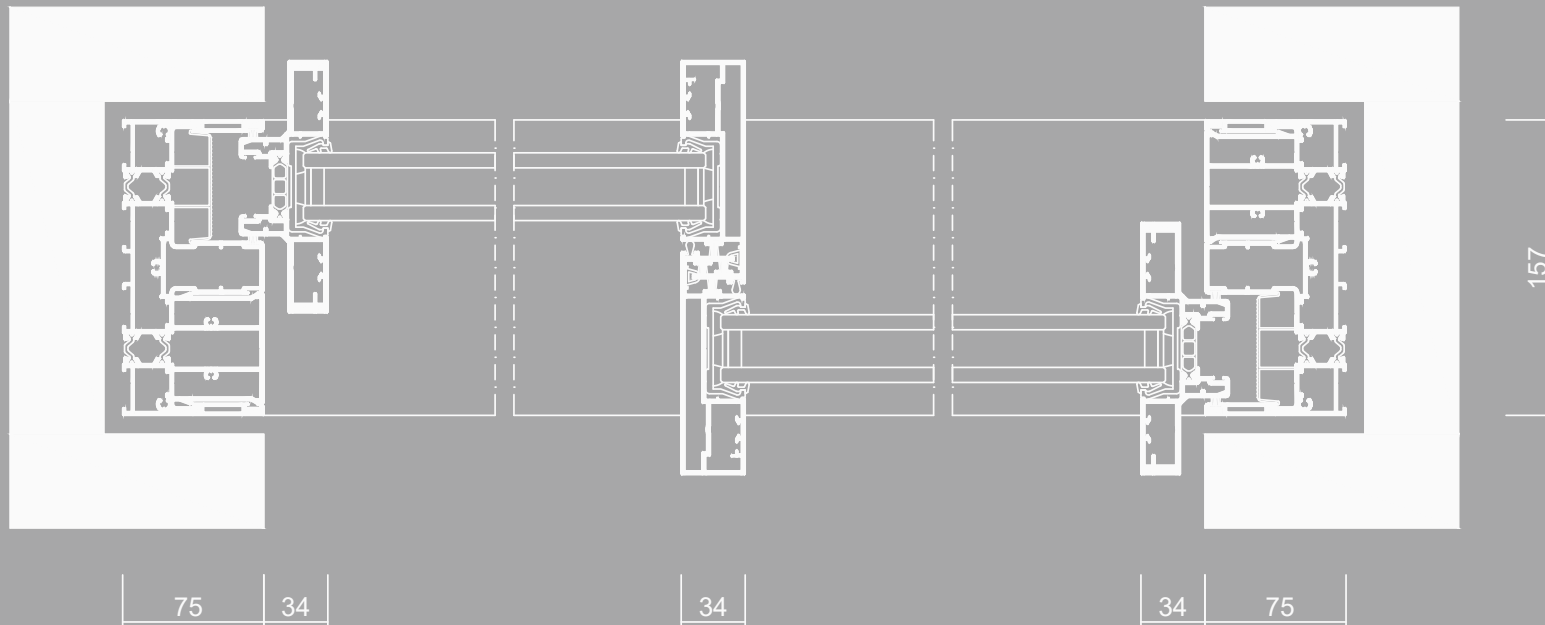

Horizontal section | without scale

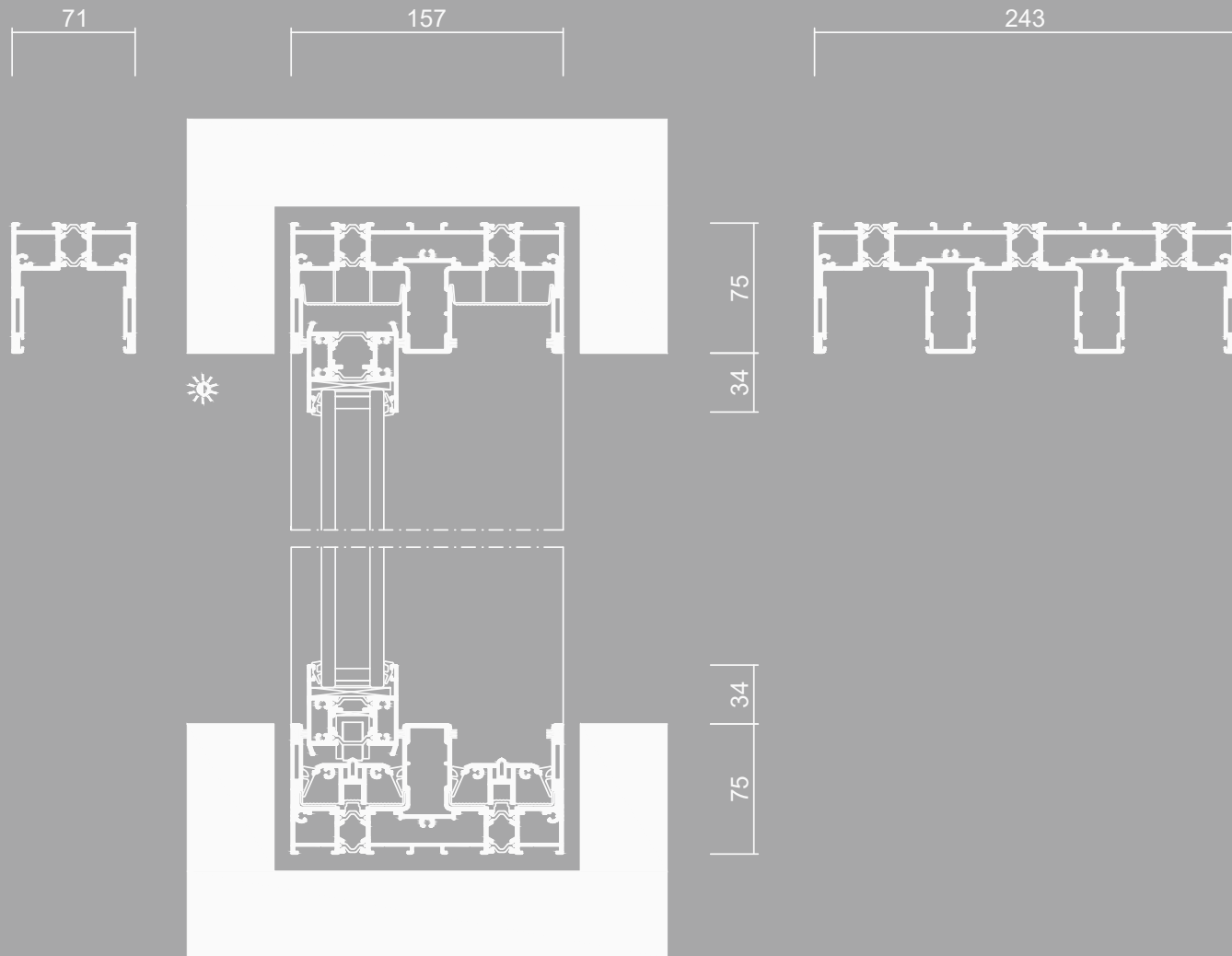

Vertical section | without scale



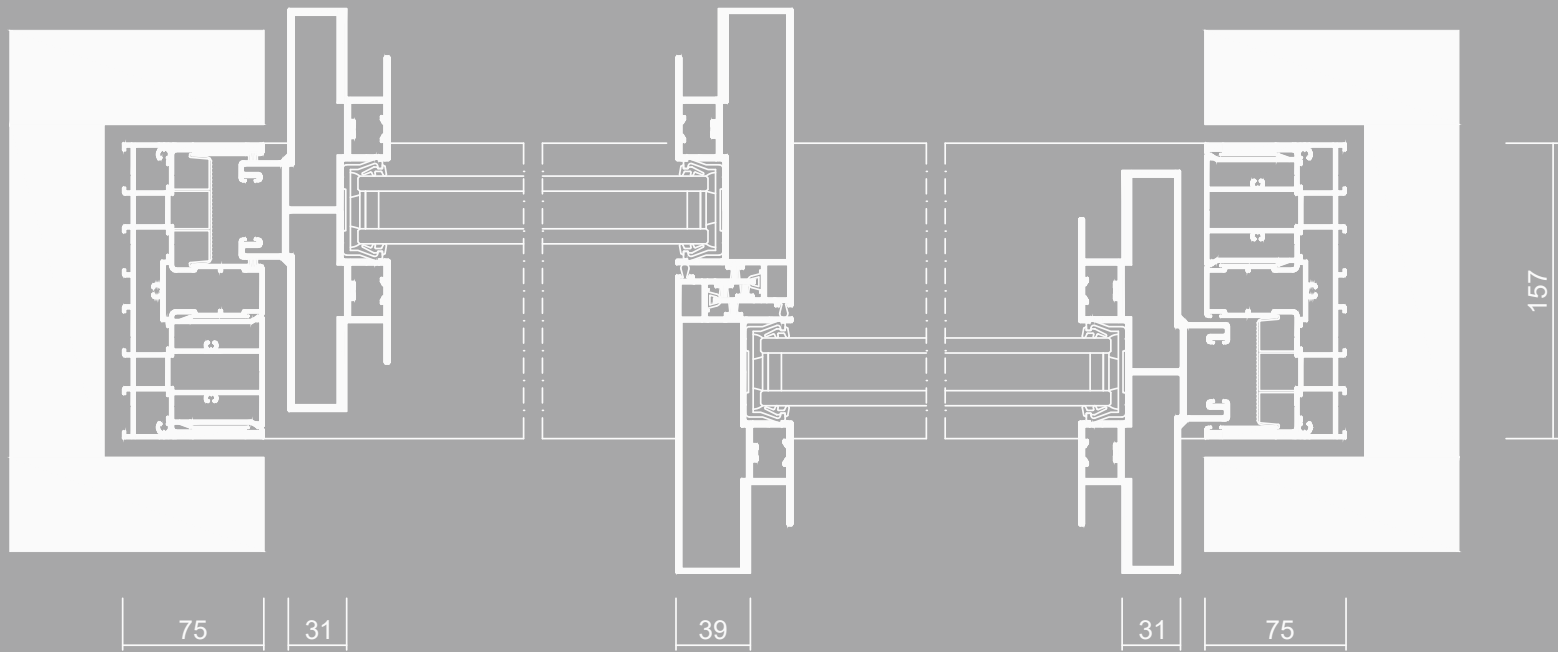

Horizontal section | without scale

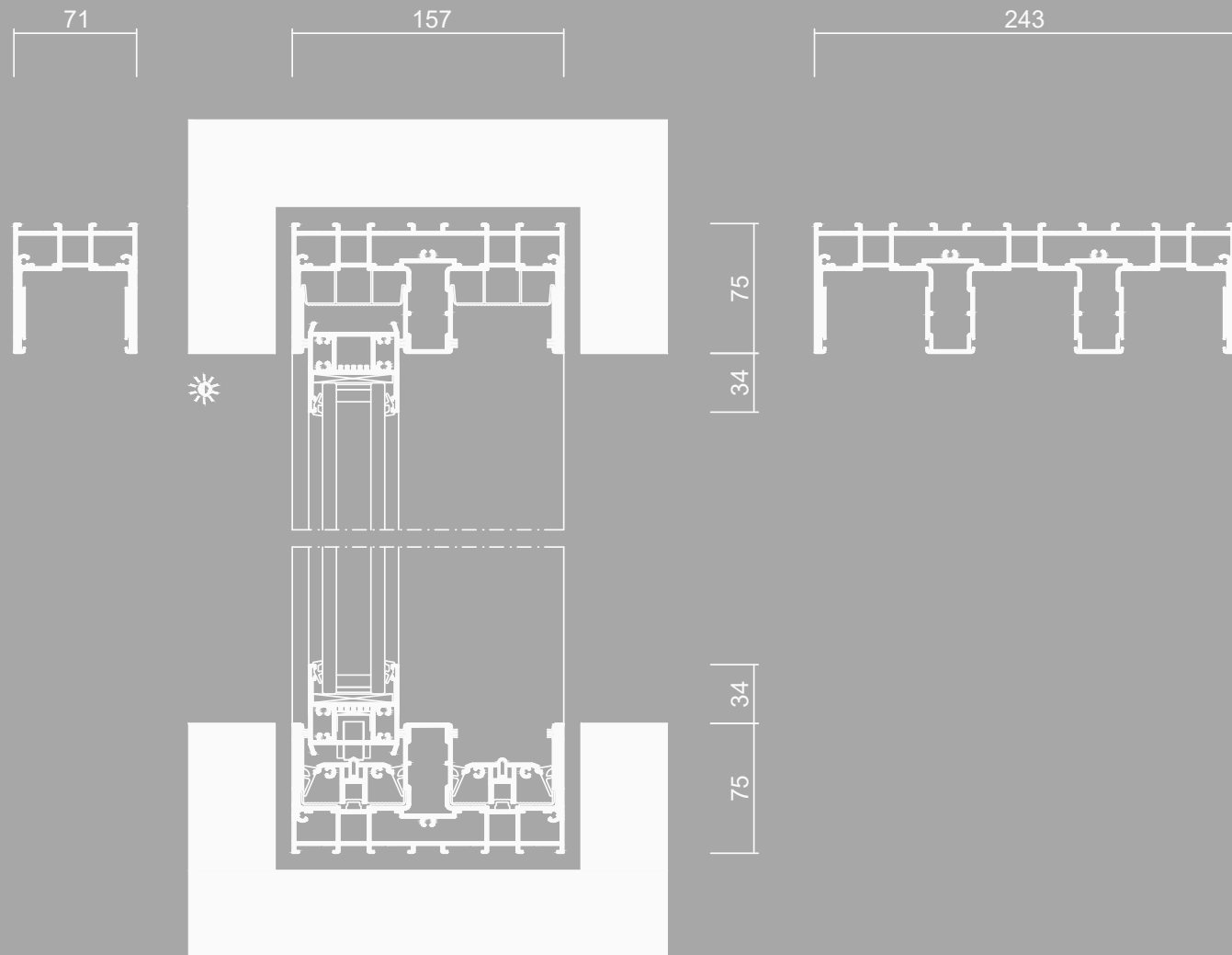

Vertical section | without scale

Additional components

Insect screen

The system is optionally available with an insect screen, made of extra fine gauze, which is up to 1 m wide and integrated in the vertical frame, to prevent unwanted guests from flying into your living space. When retracted, the insect screen is concealed by the vertical zero frame profile, and can be magnetically secured to the adjacent sliding panel when extended. The maximum height of the screen is 3 m for cero II and 3.5 m for cero III.

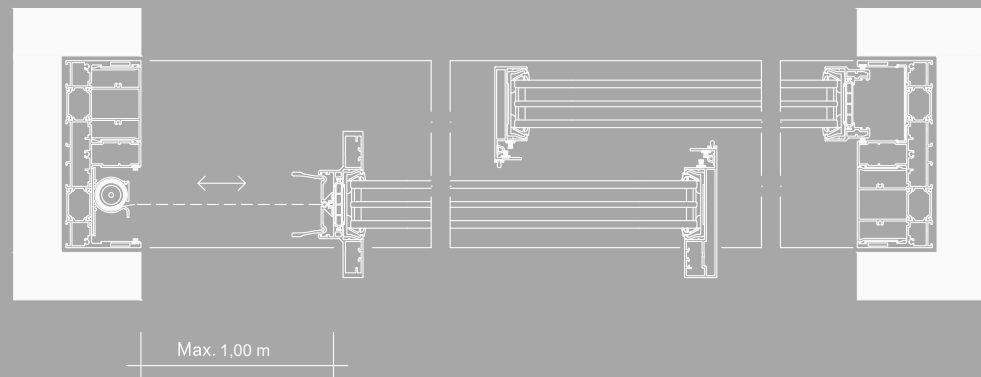



Shading

Maximum transparency offers maximum daylight. To prevent glare in your living space or ensure privacy when required, zero can be fitted with motorised vertical shading in the form of screens or lamellas. The guide rails can be coupled with the zero element frame without any issue. Optimal convenience: Some constellations can be configured via smart home, so that shading is provided automatically at certain times of day.

Screen

A screen of thin gauze offers privacy and sun protection and can be individually adjusted to the level of sunlight.





Venetian blinds

Venetian blinds offer a modern shading solution for zero elements. Thanks to different control options for the lamellas, the angle can be adjusted to control the level of sunlight in the room.

Integral windows

The requirements for projects in which zero functions as a major design feature often apply to the entire facade - including all the window elements. The Solarlux "Highline Integral" window is a highly heat-insulated aluminium window system. It is characterised by its linear profile design, without visible glass moulding joints. When viewed from the outside, the all-round window frame almost completely conceals the panel profiles.

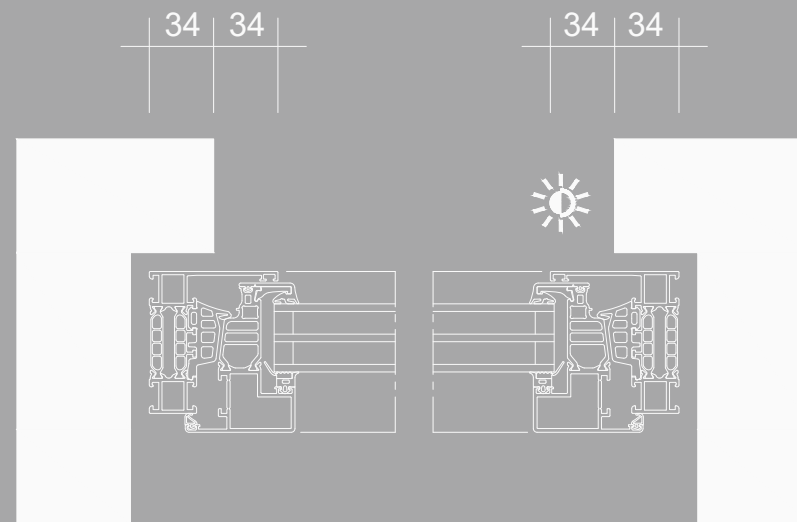

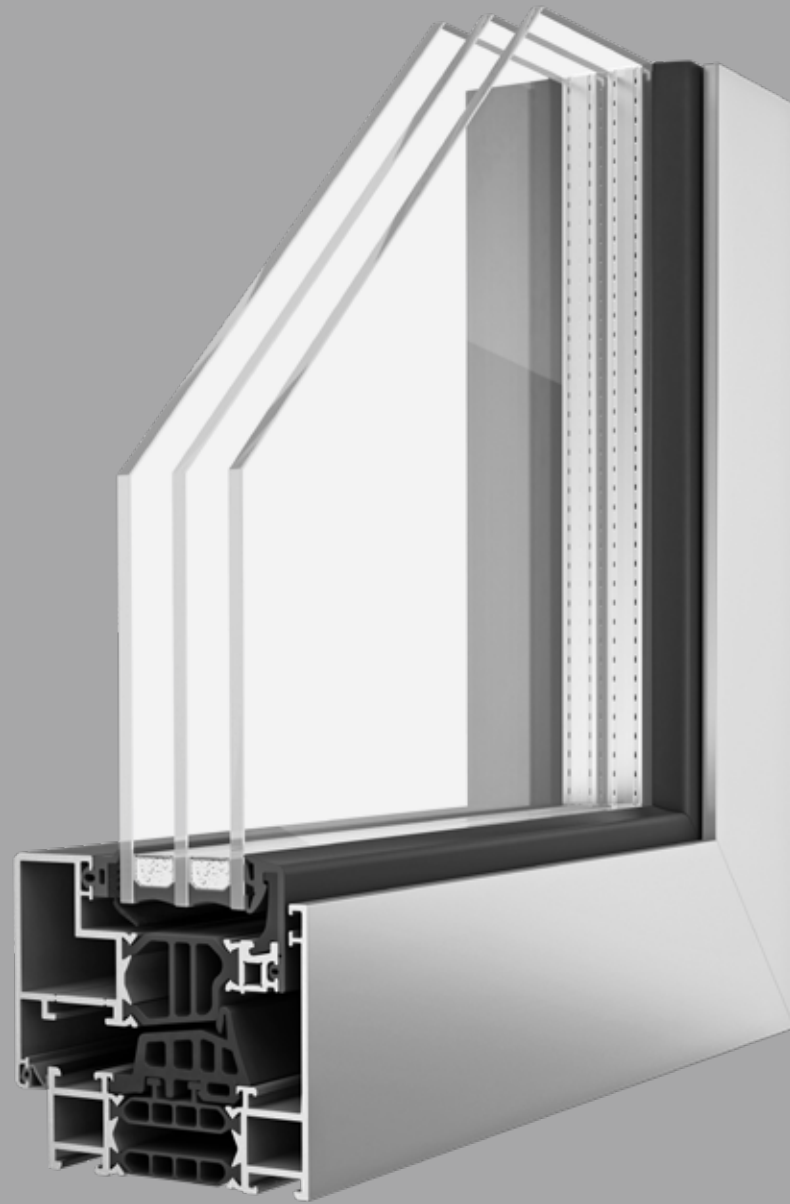





cero III

Detached house

Henstedt-Ulzburg, DE

Architect: Gnosa Architekten

Photos: Malik Pahlmann

Ref. 1679*







cero III

Detached house

Krakow, PL

Architect: Dr. Peter Kuczia

Ref. 1544*





cero III

Seminar room

Hamburg, DE

Architect: Dr. Peter Kuczia

Ref. 1705*











cero III

Restaurant Grissini

Cologne, DE

Architect: Gatermann + Schossig

Photos: Constantin Meyer

Ref. 1585*



cero III Das Brahms Innsbruck, AT Architect: Erich Strolz, Dietrich Untertrifaller Photos: Dr. Günther Egger Ref. 1647*





cero III

Villa

Hamburg, DE

Architect: Meyer Terhorst Architekten

Photos: Christiane Koch

Ref. 789*







Further references

Hotel Sand
Scharbeutz, DE
Ref. 1586*



Detached house
Black Forest, DE
Ref. 1626*



Office building
Glatten, DE
Ref. 1277*
Photo: Roland Halbe



Prora
Rügen, DE
Ref. 1335*



Detached house
Starnberger See, DE
Ref. 780*



**West Side
Chicago
Residence**
Chicago, USA
Ref. 1631*



Detached house
Freiburg, DE
Ref. 1447*



Detached house
The Hague, NL
Ref. 1222*



Villa
Budapest, HU
Ref. 1644*



Detached house
Oldenburg, DE
Ref. 1673*



Detached house
Nottinghamshire,
GB, Ref. 1628*



**“Ocean”
cruise terminal**
Hong Kong, CN
Ref. 1457*



Spa area
Leipzig, DE
Ref. 1559*



Car dealership
Stockach, DE
Ref. 1445*



cero by Solarlux

System solutions

“We don’t think in terms of individual profiles, but in terms of systems.” This principle has guided Solarlux since it was first founded in 1983, and is still pursued by Stefan Holtgreife, the second-generation company owner and managing director. Precise fits, flawless details, intelligent combination options and motorisation are characteristic of cero. Every cero element is exclusively produced and further developed at the Solarlux’s headquarters in Melle, Germany. Almost 40 years of experience in glass fronts and extensions not only guarantee a smooth planning process, but equally smooth installation and project management on the construction site as well.

- 900 employees
- 57,000 m² production facility in Melle, Germany
- Cutting-edge coating plants and painting lines
- Internationally certified manufacturing standards
- International projects in over 60 different countries







Sustainability

As a company with the highest standards, Solarlux is certified for quality and environmental management in accordance with ISO 9001 and ISO 14001. Sustainability and the responsible consumption of resources are a consistent standard throughout the entire company. From a photovoltaic system with an area of almost 4,000 m² to a geothermal field, the reuse of process heat and the recycling of aluminium - "green" at Solarlux encompasses more than just the Solarlux Campus.

Certificates

National and international certificates attest to the durability, quality and expertise inherent in Solarlux systems - of course, all featuring the CE mark. However, Solarlux not only stands out as a company; its processes do too. For example, cero sliding windows and all other facade solutions and glazed extensions are tested by independent test institutes. These independently certify features such as thermal insulation, impermeability to driving rain, structural properties or anti-burglary protection on a regular basis.

Services

When you opt for cero, you get more than just a premium system. When it comes to calculation, planning, service and logics, you get the full support of a reputable, professional company to back up the product with Solarlux. During the planning phase, an experienced advisor will advise you on design variants, combination options and your individual design, and offer technical support at every stage of the project. Our construction management team has lots of experience in handling large, even international building projects. This ensures the quick and efficient completion of your entire project.

Logistics

Smooth-running logistics with its own fleet and special cranes as well as an assembly team that specialises in the complex installation of large glass surfaces, with a weight of up to 1,000 kg per glass pane, guarantee a smooth process from start to finish. Complex installation situations or hard-to-access construction sites are taken into account right from the start. A high degree of pre-fabrication allows rapid on-site assembly without the need for elaborate customisation.



Materials

In a system like cero, the quality is not only visible, but fully “tangible” from day to day, in the truest sense of the word. Made of high-quality aluminium, cero is not only durable but practically maintenance-free. This is made possible in part by the high-quality coating of the profiles, which is exclusively applied in a shielded, dust-free cleanroom in Solarlux's 5,300 m² coating facility. This is one of the most cutting-edge coating plants in Europe Solarlux's GSB certification as a “premium coater” and “sea proof” add-on certification confirm these high quality standards. Thanks to its high surface quality, cero is also suitable for use in extreme weather conditions or near the sea.

Distinctive accents in one-off projects can also be realised using special colours and surface finishes. As well as around 30 RAL colours with a matt and silk gloss finish, which are available from Solarlux at no extra cost, it is also possible to realise special colours in RAL, DB or Eloxal in accordance with EURAS, as well as special surface finishes using gloss effects (e.g. from the manufacturer Tiger).





Digital and direct

We offer various forms of assistance for every stage of the planning phase - both digitally and directly in our showrooms, as well as through experienced specialist partners.

mySolarlux

On our protected portal, mySolarlux, you will find CAD details, structural joints, sample configurations and other technical planning documents for all Solarlux systems. Registering for the portal is quick and easy: <https://my.solarlux.com>

Spaces Online

Over 600 project documents are available online on the web-based, browser-independent reference database "Spaces". All references are assigned a number, allowing them to be quickly located in the database. The systematic search functionality provides inspiration by allowing users to search for specific building typologies, Solarlux systems or locations. By clicking on the links provided, users can view more detailed project reports and information on the product range and products used, as well as technical information: <https://spaces.solarlux.com>

BIM data

In partnership with BIM Systems, we are pleased to introduce a new interface for generating BIM data. In addition, we offer individual BIM data as IFC on demand.

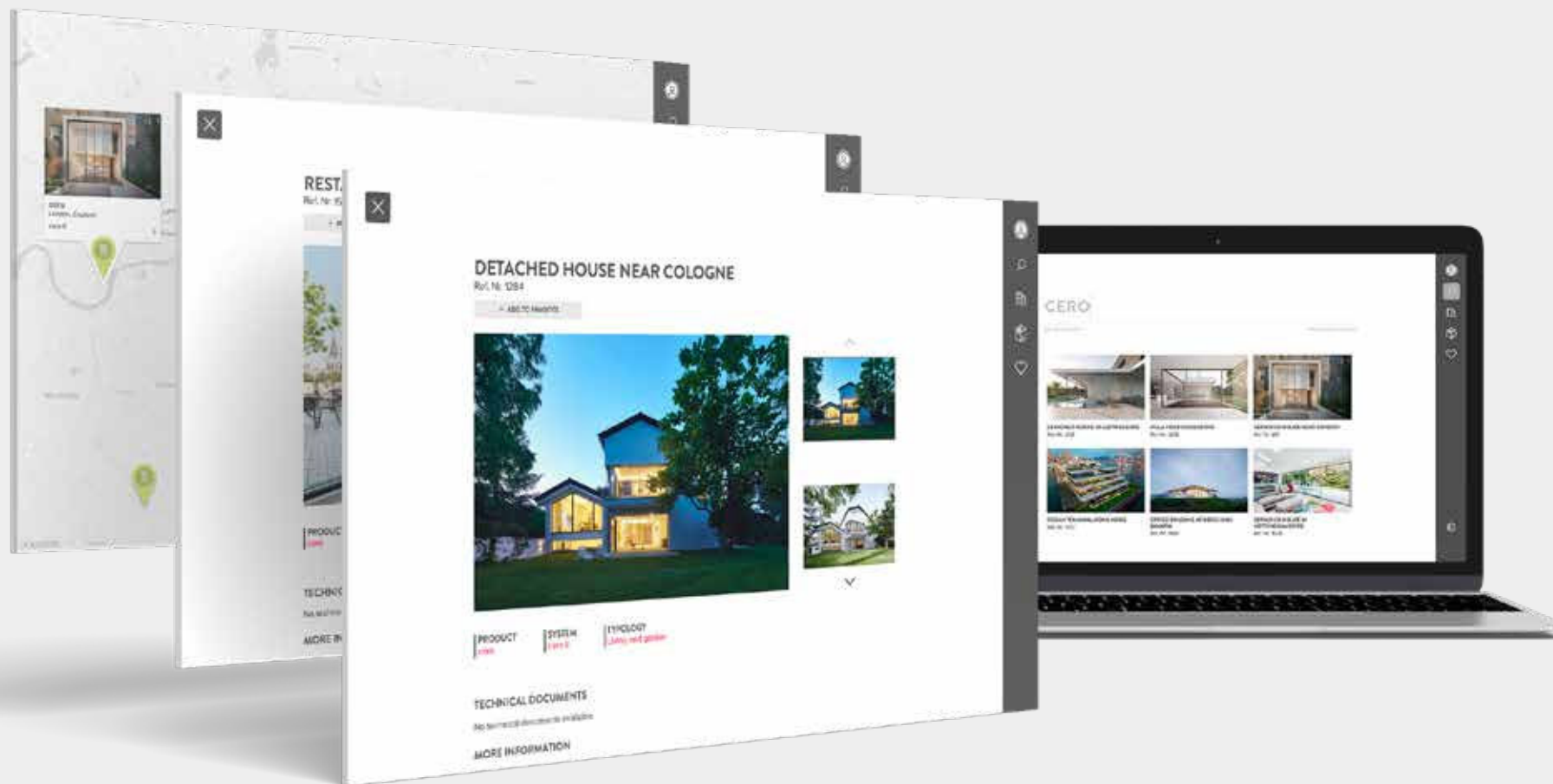

Let our Solarlux colleagues advise
you on cero:

United Kingdom and Ireland
5 Quadrant Park, Mundells
Welwyn Garden City, AL7 1FS
M +44 01707 339970
info.uk@solarlux.com

